

Temporal decoupling of carbon and nitrogen dynamics in a mesocosm diatom bloom

Anja Engel,¹ Sarah Goldthwait, Uta Passow,¹ and Alice Alldredge

Marine Science Institute, University of California, Santa Barbara, California 93106

Abstract

Flows of the major biogeochemical elements (C, N, P, Si) and of transparent exopolymer particles (TEP) were traced during a bloom of a natural assemblage of marine diatoms in a mesocosm (1 m³) to determine whether the exudation and subsequent gelation of carbon-rich phytoplankton exopolymers can account for the formation and potential export of carbon in excess of that predicted by Redfield ratios. Exponential growth of the phytoplankton community in the mesocosm extended for 10 d until nitrate concentration fell below detection and concentrations of dissolved inorganic and particulate organic nitrogen and phosphorus remained stable. Tight covariation of particulate organic elements occurred as long as nutrients were replete. But, after nitrate depletion, decoupling of carbon dynamics from that of nitrogen and phosphorus was observed, with a large flow of carbon into TEP. An uptake of 72% more dissolved inorganic carbon (DIC) than inferred from nitrate supply and Redfield stoichiometry (referred to as carbon overconsumption) occurred during the study, largely during the postbloom phase, and was almost entirely traced to the particulate organic matter (POM) pool. Marine snow (aggregates >0.5 mm) appeared at the onset of nitrate depletion and coincided with rapid increase in TEP concentrations. Elemental composition of marine snow differed from the Redfield ratio by an enrichment in carbon and a depletion in phosphorus relative to nitrogen. It is suggested that sinking of TEP-rich marine snow could be a possible mechanism for export of carbon above calculations that are based on the Redfield stoichiometry.

An essential tool for the calculation of oceanic carbon fluxes in biological models is the Redfield ratio (Redfield et al. 1963), since it describes a fixed covariation of the elements C, N, and P in a ratio of 106:16:1. The Redfield ratio implies a reciprocal interaction between the elemental composition of marine biota and their dissolved nutrition resources. Organisms or, more generally, particulate organic matter (POM) leaving the upper mixed layer should export this ratio to the deep ocean and leave its imprint on the stoichiometry of remineralization products. Indeed, in the deep ocean the covariation of the major nutrients nitrate and phosphate and the amount of oxygen used (AOU) for oxidation of organic carbon seem to reflect this ratio almost perfectly. The theoretical framework for the calculation of carbon export from nitrate fluxes was introduced by Dugdale and Goering (1967), who differentiated between new biological production based on nitrate and regenerated production based on the degradation products of organic nitrogen compounds. Eppley and Peterson (1979) later concluded that the amount of carbon being exported to the deep sea should be equal to new production on long temporal scales. Recent investigations, however, demonstrated that the net uptake of dissolved inorganic carbon (DIC) exceeds the amount expected from nitrate removal and Redfield stoichiometry at various marine sites (Sambrotto et al. 1993; Michaels et al. 1994; Marchal et al. 1996). Possibilities that may cause this discrepancy include underestimation of the nitrogen avail-

able due to unaccounted for biological N₂ fixation, only temporary accumulation of carbon-rich dissolved organic matter (DOM), and/or preferential nutrient recycling. Banse (1994) pointed out that biological uptake of carbon and nitrogen may be temporarily decoupled due to different dynamics of the POM and DOM pools. Unresolved as well is the question of whether part of this overconsumed carbon, specifically carbon generated by uptake of more DIC than inferred from nitrate supply and Redfield stoichiometry, is exported to the deeper ocean. Elevated POC:PON ratios in material collected from sediment traps over wide depth ranges or from the deep sea floor are common (e.g., Honjo and Maganini 1993; Loh and Bauer 2000). Because this material has surely undergone chemical alteration after its production, it remains unclear whether the POC:PON ratio was high originally or increased a posteriori.

We need to consider the nature of the sinking material if we want to determine whether particles can export carbon above predictions based on Redfield stoichiometry. Large particles such as fecal pellets and marine snow are of major importance for the rapid export of POM to the deep sea (Fowler and Knauer 1986). These large particles are predominantly formed during and at the end of phytoplankton blooms, especially diatom blooms (Alldredge and Gotschalk 1989). Carbohydrate gels known as transparent exopolymer particles (TEP) play an important role in the aggregation of particles to form marine snow in these blooms (Alldredge et al. 1993; Logan et al. 1995; Engel 2000). TEP are especially abundant during phytoplankton blooms (Passow and Alldredge 1994). They originate from extracellular carbohydrates exuded by microbes, especially diatoms (Passow 2000), and, unlike living biota, their formation is not necessarily tied to nutrient availability (Corzo et al. 2000). Moreover it has recently been shown that the C:N ratio of TEP frequently exceeds the Redfield ratio (Engel and Passow 2001).

Given the numerous indications that the biogeochemistry

¹ Present address: Alfred Wegener Institute for Polar and Marine Research, 27515 Bremerhaven, Germany.

Acknowledgments

We are grateful to Bob Petty and Gavin Fukada for technical assistance with the chemical analysis. We also thank the anonymous referees for valuable comments on the manuscript. This work was supported by the Deutsche Forschungsgemeinschaft (DFG) (grant EN 416/1-1) and NSF grant OCE 9906827.

during phytoplankton blooms and the elemental composition of marine snow does not always follow Redfield's predictions, we examined the C, N, P, and Si stoichiometry of a mixed diatom bloom initiated with natural seawater in a mesocosm under the hypothesis that TEP can account for the formation and potential export of carbon in excess of that predicted by the Redfield ratio.

Material and methods

A diatom-dominated phytoplankton bloom was initiated and monitored over a period of 20 d in a cylindrical fiberglass tank as described in detail in Alldredge et al. (1995). The tank was placed in an environmental chamber set at 11°C. Seventy-six liters of unfiltered seawater collected in the Santa Barbara channel at 6-m depth were added to 1,150 liters of sand filtered seawater, yielding an initial water height in the tank of 90 cm. The water in the tank was continuously stirred with a 70 cm long Plexiglas propeller positioned 5 cm above the bottom at a rate of 2.5 rotations per minute (rpm). Nutrients were added at the start of the experiment to ensure bloom development sufficient for aggregate formation to occur and yielded an initial concentration of 35 $\mu\text{mol L}^{-1}$ NO_3 , 0.5 $\mu\text{mol L}^{-1}$ NH_4 , 46 $\mu\text{mol L}^{-1}$ Si(OH)_4 , and 2.8 $\mu\text{mol L}^{-1}$ PO_4 , which correspond to deep water nutrient concentrations in the Santa Barbara Channel. Thirty milliliters of metal stock solution and 15 ml of vitamin stock solution prepared after the F/2 recipe were also added initially. A halogen light source was suspended above the tank, giving a surface irradiance on the order of 115 $\mu\text{mol photons m}^{-2} \text{ s}^{-1}$ with a light:dark cycle of 14:10. Irradiance within the tank was monitored every day with a LICOR Model LI-250 light meter. Temperature and salinity profiles were taken daily with a Seabird SBE 19 CTD.

Biological and chemical analyses—Water was sampled from a spigot, which protruded 20 cm into the tank at 60 cm depth, every second day during the first week and every day thereafter. For nutrient measurements triplicate 40-ml samples were filtered through a 0.45- μm syringe filter into 50-ml polyethylene vials and stored at -30°C until analysis by an autoanalyzer for NO_3 , NO_2 , NH_4 , Si(OH)_4 , and PO_4 according to Johnson et al. (1985). Particulate organic carbon (POC), nitrogen (PON), and phosphorus (PP) were analyzed from 200–600-ml samples filtered onto precombusted GF/F glass fiber filters. POC and PON were determined with a CHN (carbon-hydrogen-nitrogen) analyzer (Leeman Labs Model CE 440) according to Sharp (1992). PP was measured as soluble reactive phosphate according to Koroleff and Grasshof (1983) after persulfate oxidation. Chlorophyll *a* (Chl *a*) was determined fluorometrically according to Parsons et al. (1984) from 2–10-ml samples filtered onto GF/F filters. Biogenic silica (BSi) was determined from 200–500-ml samples filtered onto 0.4- μm polycarbonate filters and analyzed according to Brzezinski and Nelson (1989) with a 40-min digestion at 95°C. Transparent exopolymer particles (TEP) were determined according to Passow and Alldredge (1995) from 20–50-ml samples filtered onto 0.4- μm Nucleopore filters. All filters were prepared in triplicate and stored at -30°C until analysis. Carbon content of TEP was

calculated from colorimetrically determined TEP concentration (in μg Xanthan equivalents [Xeq.] L^{-1}) applying a conversion factor of $\text{TEP-C} (\mu\text{g}) = 0.75 \times \text{TEP} (\mu\text{g Xeq.})$, after Engel and Passow (2001).

Phytoplankton abundance and species composition were determined from 10 to 25 ml of 1% Formalin fixed samples using an inverted Zeiss microscope with $\times 400$ magnification. Concentration and size distribution of solid particles between 2 and 60 μm equivalent spherical diameter (ESD) were determined with the Coulter Counter (Coulter Multisizer II) from replicate 2-ml aliquots of 1% Formalin fixed samples. A dilution with filtered seawater ($<0.16 \mu\text{m}$) on the order of 1:2–1:4 was necessary to keep coincidence of particles at the aperture $<5\%$.

Primary production was approximated from oxygen evolution in bottle incubations. Water was sampled at 09:00 h through a tube connected with the spigot directly into 300-ml glass bottles (BOD) and incubated immediately. One dark and two light bottle incubations were performed for 6 h on days 2–15 and for 3 h on days 16–20. In order to get an average value for primary production in the tank, one light bottle was positioned right below the surface and the second light bottle between 60 and 70 cm depth, where roughly 15–20% of surface light was attained. Initial oxygen concentration was determined immediately from two additional bottles. Oxygen concentrations were determined with an Orion oxygen electrode Model 97-08, accuracy 0.05 ppm, range 0–14 ppm. Community production was calculated from O_2 concentrations. Daily gross community production (GP, $\mu\text{mol C L}^{-1} \text{ d}^{-1}$), defined as gross production within the 14 h of illumination, was calculated as follows:

$$\text{GP} = \left(\frac{(\text{O}_{2\text{light}} - \text{O}_{2\text{dark}}) \times 14 \text{ h}}{\Delta t} - (2 \times F_{\Delta\text{NO}_3}) \right) \times \frac{1}{\text{PQ}} \quad (1)$$

where $\text{O}_{2\text{light}}$ is the average oxygen concentration ($\mu\text{mol O}_2 \text{ L}^{-1}$) of the light incubations at the surface and at 60–70 cm depth, $\text{O}_{2\text{dark}}$ is the oxygen concentration of the dark bottle ($\mu\text{mol O}_2 \text{ L}^{-1}$), and Δt is the incubation time (h). Daily oxygen production was corrected by the oxygen produced during NO_3 uptake because reduction of NO_3 to NH_4 within the cell generates two moles of O_2 . The NO_3 uptake per day considered was assumed to be equal to the respective decrease of NO_3 concentration in the mesocosm on that day ($F_{\Delta\text{NO}_3}$, in $\mu\text{mol O}_2 \text{ L}^{-1}$). The photosynthetic quotient (PQ) is the molar ratio of oxygen production to carbon assimilation and was assumed to be 1.08 (Laws 1991). Daily net community production (NP, $\mu\text{mol C L}^{-1} \text{ d}^{-1}$), which is the gross production subtracted by respiration, including light, dark, and heterotrophic respiration during the 14 h of illumination and the remaining 10 h of darkness, is a measure of net DIC uptake and was calculated as

$$\text{NP} = \left(\frac{(\text{O}_{2\text{light}} - \text{O}_{2\text{initial}}) \times 14 \text{ h}}{\Delta t} - \frac{(\text{O}_{2\text{initial}} - \text{O}_{2\text{dark}}) \times 10 \text{ h}}{\Delta t} - (2 \times F_{\Delta\text{NO}_3}) \right) \times \frac{1}{\text{PQ}} \quad (2)$$

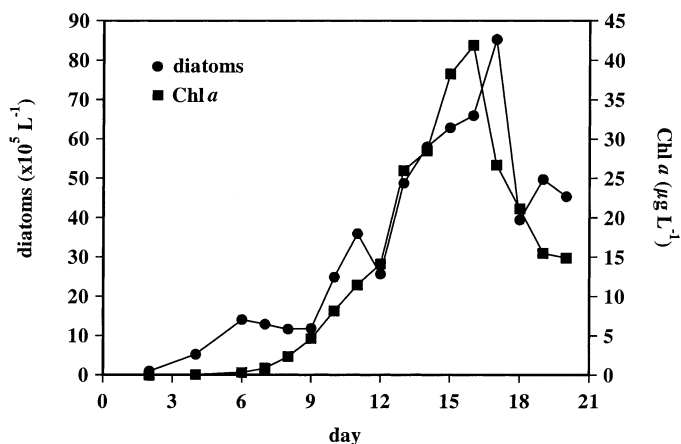

Fig. 1. Development of a diatom-dominated phytoplankton bloom inside the mesocosm.

Temperature and pH before and after the incubations were measured using a PerpHec T Ag/AgCl probe (Orion, Model 9272) with a PerpHec T Meter (Orion, Model 350). Alkalinity was determined at the beginning and end of the study according to Parsons et al. (1984). Concentrations of total dissolved inorganic carbon (DIC) and its component CO_2 in the mesocosm were calculated from pH, temperature, and alkalinity data according to the calculation scheme of Peng et al. (1987) with the aid of the CO_2sys -software developed by Lewis and Wallace (1998).

Sampling and analysis of marine snow—On five days (days 16–20) visible aggregates (>1 mm) were sampled manually from the mesocosm with a syringe. Each aggregate slurry consisted of a mixture of aggregates and surrounding seawater (SSW). Particulate components of the aggregate slurries were analyzed according to the methods described above using the following filtration volumes: 5–10 ml for TEP, 5–20 ml for POC and PON, 5–10 ml for PP, and 5–10 ml for BSi. Owing to manual isolation, aggregates comprised a relatively small volume of the slurry. Particle concentration, however, is generally 2–4 orders of magnitude higher in aggregates. In order to obtain a conservative estimate for the particulate composition in the aggregates, all concentrations of particulate components in the SSW were subtracted from those in the slurry.

Results

General bloom development—Exponential growth of phytoplankton within the mesocosm started about 1 week after inoculation and lasted for approximately 10 days, until reaching a peak concentration of $43 \mu\text{g Chl } a \text{ L}^{-1}$ on day 16. Diatom abundance peaked 1 day later at roughly $8.5 \times 10^6 \text{ N L}^{-1}$ (Fig. 1). Species composition was rich, with at least 32 different diatom species identified. Species of the genus *Thalassiosira* sp.; *Nitzschia* sp. dominated by *N. closterium*; *Chaetoceros* sp., especially *C. affinis* and *C. decipiens*; species of *Amphiphora* sp.; and *Skeletonema costatum* were dominant. After day 16 a decrease of Chl *a* concentra-

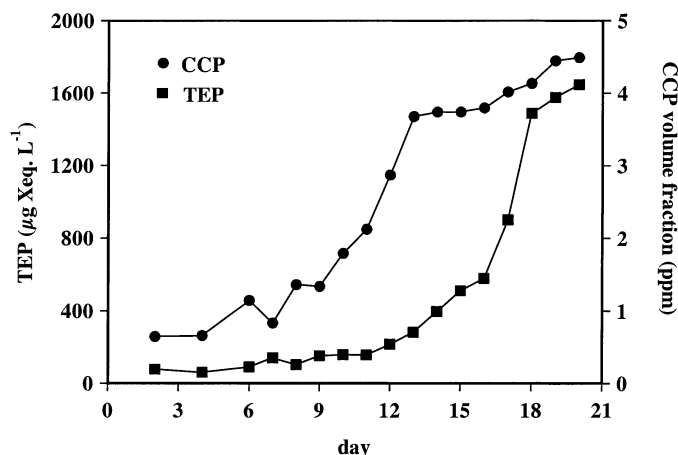

Fig. 2. Abundance of Coulter counter detectable particles (CCP) and transparent exopolymer particles (TEP) during the bloom.

tion and diatom abundance indicated the decline of the bloom.

A fourfold increase of Coulter Counter detectable particles (CCP) within the first 2 weeks was concomitant with the bloom development. However, the volume fraction of CCP did not decline afterward but remained almost constant at about 4 ppm and even increased slightly during the last 4 days (Fig. 2). This shows that the particulate biomass remained roughly constant in the postbloom phase, while the phytoplankton abundance obviously decreased and indicated a shift from an almost pure autotrophic to a mixed community, including heterotrophs and detritus. The increase of transparent exopolymer particles (TEP) was small during exponential phytoplankton growth but increased sharply after day 15 from about $500 \mu\text{g Xeq. L}^{-1}$ to $1,600 \mu\text{g Xeq. L}^{-1}$ at the end of the study (Fig. 2).

During the bloom the decrease in dissolved inorganic nutrients PO_4 , NO_3 , and Si(OH)_4 corresponded to an increase of particulate organic elements PP, PON, and BSi equivalent to $2.3 \mu\text{mol P}$, $29 \mu\text{mol N}$, and $45 \mu\text{mol Si}$ (Fig. 3A–C). Ammonium concentration was on average $0.35 \mu\text{mol L}^{-1}$ (SD: $0.12 \mu\text{mol L}^{-1}$) and exhibited no temporal trend. No significant net increase of PON and PP was observed after day 15 when nutrient concentrations fell below $0.6 \mu\text{mol L}^{-1} \text{NO}_3$ and $0.3 \mu\text{mol L}^{-1} \text{PO}_4$. Uptake of nutrients altered dissolved elemental N:P:Si ratios from 13:1:17 initially, to 7:1:1 at the end of the study. Thus, the lowest N:P ratio of 3:1 coincided with the lowest P:Si ratio of 1:36 on day 15, which indicates that the transition from the exponential to the stationary phase in the bloom development was due to nitrogen exhaustion.

DIC concentration within the mesocosm decreased from an initial $2,200 \mu\text{mol L}^{-1}$ to $1,800 \mu\text{mol L}^{-1}$ at the end of the study. Accordingly O_2 concentration increased from $218 \mu\text{mol L}^{-1}$ to $414 \mu\text{mol L}^{-1}$ (Fig. 4A). Draw down of DIC, especially CO_2 , caused an increase in the pH of the water from approximately 8.2 to 8.8 (Fig. 4B). The proportionality between DIC uptake and O_2 production in the mesocosm was not determined because of different exchange rates of gaseous O_2 and CO_2 across the air–water interface.

POC concentration increased from $20 \mu\text{mol L}^{-1}$ to 200

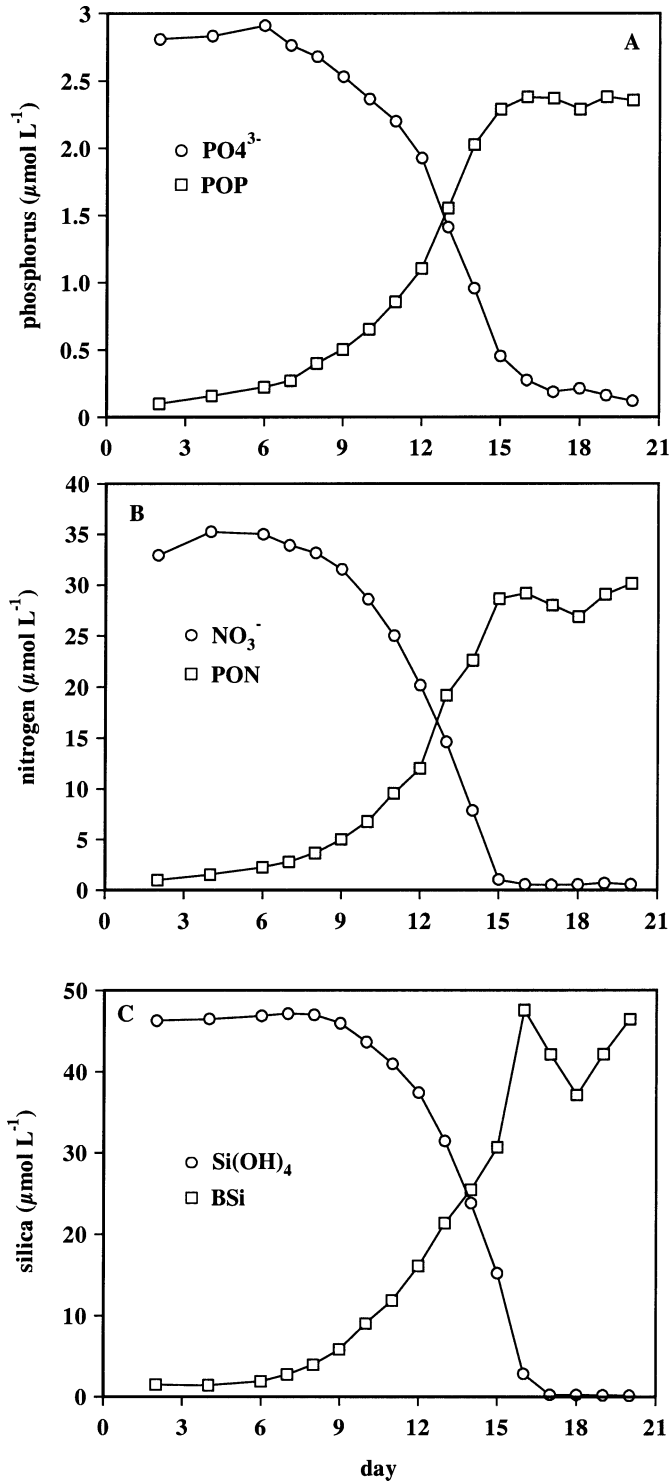

Fig. 3. Reciprocal interaction between the dissolved inorganic elements and particulate organic elements of (A) phosphorus, (B) nitrogen, and (C) silica due to biological growth.

$\mu\text{mol L}^{-1}$ during exponential growth of phytoplankton and, in contrast to PON and PP, continued to increase thereafter (Fig. 5). Carbon contained in TEP (TEP-C) was $100 \mu\text{mol L}^{-1}$ at the end of the study, equivalent to 27% of POC. The increase of POC during the whole study corresponded to

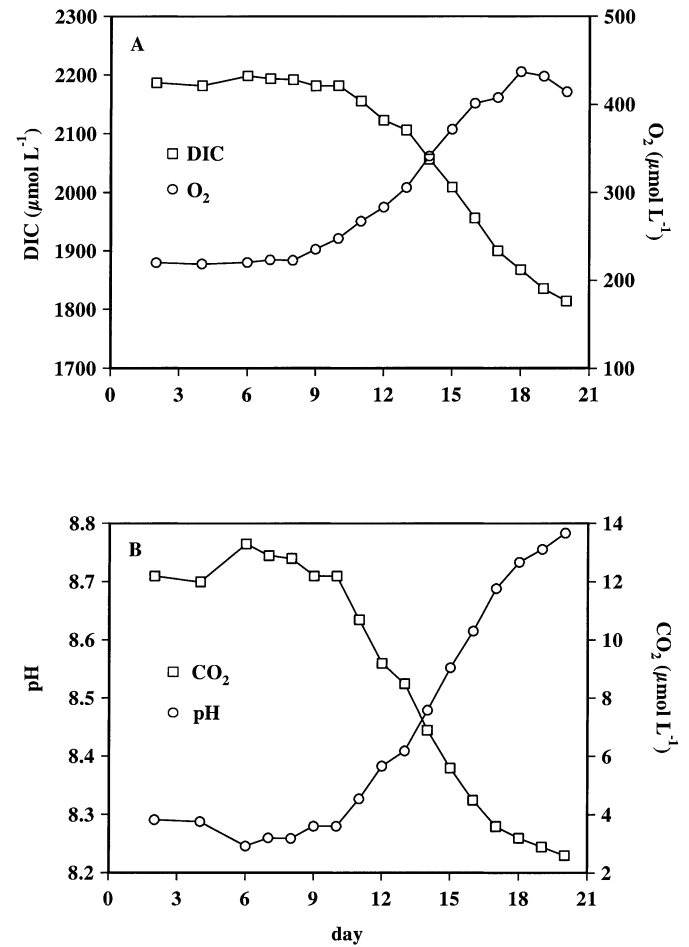

Fig. 4. (A) Inverse development of dissolved inorganic carbon (DIC) and oxygen concentrations in the mesocosm. (B) Draw down of CO_2 during the phytoplankton bloom and consequent increase in the pH of the water.

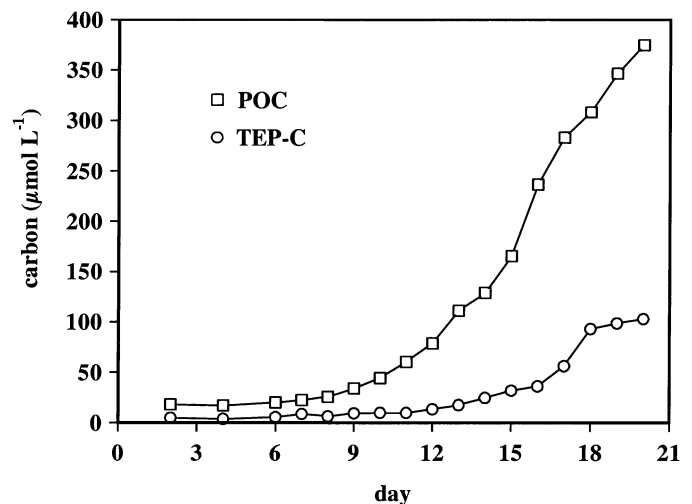

Fig. 5. Particulate organic carbon (POC) production during the study and carbon contained in TEP.

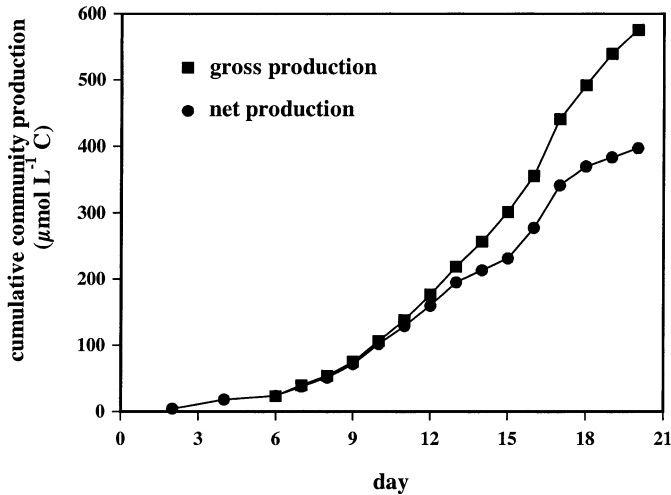

Fig. 6. Cumulative gross community production and cumulative net community production as calculated from oxygen concentrations in the bottle incubations.

90% of total net production. Net production was similar to gross production until day 13 but clearly smaller afterward, indicating significant respiration due to heterotrophic growth (Fig. 6). Total net production was about 72% higher than the theoretical value calculated from DIN decrease assuming a C:N conversion of 106:16. After the onset of exponential growth, net production rates varied around a mean value of $27 \mu\text{mol C L}^{-1} \text{d}^{-1}$, while gross production rates varied around $40 \mu\text{mol C L}^{-1} \text{d}^{-1}$. Carbon and Chl *a* specific gross production rates declined continuously during the exponential growth phase but increased temporarily after nutrient depletion (Fig. 7).

Covariation of POC with PON was tight during the exponential growth phase of the bloom ($r^2 = 0.998$, $n = 11$). Regression analysis of molar concentrations of POC versus PON yielded a slope of $\Delta\text{POC}:\Delta\text{PON}$ of 5.4 ± 0.05 until day 15. Afterward POC and PON dynamics were clearly decoupled; while PON remained constant, POC more than doubled (Fig. 8) causing an increase in molar [POC]:[PON] ratios from 5.7 to 12.4 (Fig. 9).

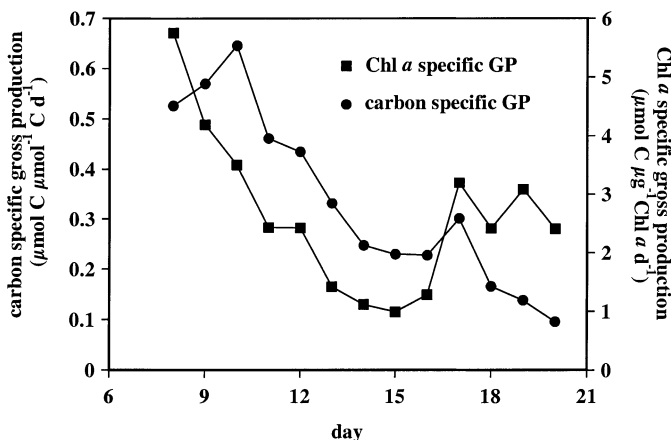

Fig. 7. Specific gross community production rates related to Chl *a* and POC.

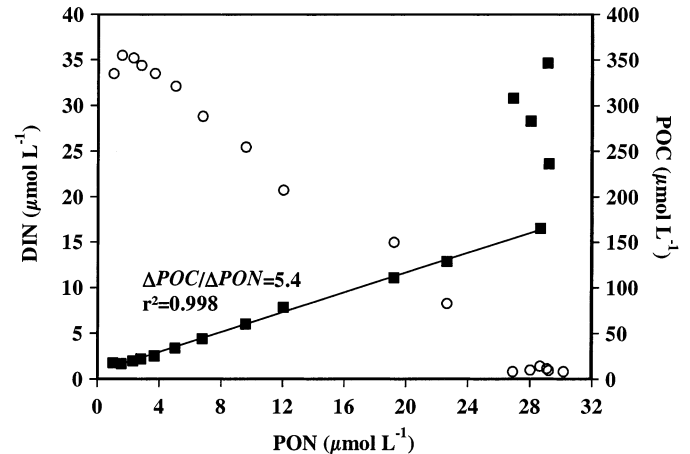

Fig. 8. Decoupling of carbon and nitrogen dynamics during the bloom. Tight covariance of POC and PON was given until DIN depletion. Then POC increased but PON remained almost constant.

Budget calculations—Considering the different dynamics of carbon and nitrogen, the study period can be divided into two phases. First, an exponential, resource replete growth phase of the phytoplankton community extended from day 4 until day 15, when nitrate dropped to minimum values. Second, a nitrate-depleted phase occurred after day 15 when no net changes were observed in the dissolved inorganic and particulate organic nitrogen and phosphorus pools.

During the exponential growth phase, statistically significant covariations ($p < 0.001$) between the elements C, N, P, and Si allowed for the calculation of reaction rate ratios. The calculation scheme, which describes the changes in the element pools during the exponential growth phase, should be read as follows (Fig. 10A): a decrease of 100 molar units (MU) of DIC due to net primary production caused an increase of 62 MU of POC. Theoretically, the remaining 38 MU must have been channeled into the DOC pool. The de-

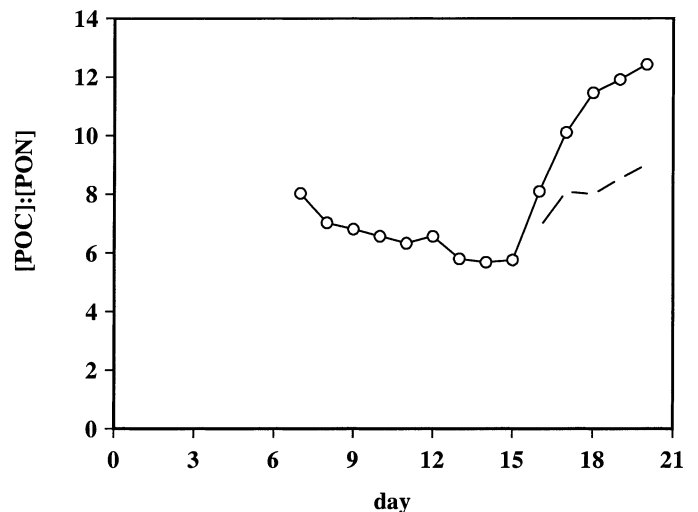

Fig. 9. Increase of the molar concentration ratio [POC]:[PON] toward the end of the diatom-dominated phytoplankton bloom. Broken line indicates theoretical molar [POC]:[PON] ratios of particles without TEP, assuming all TEP present were measured as POC.

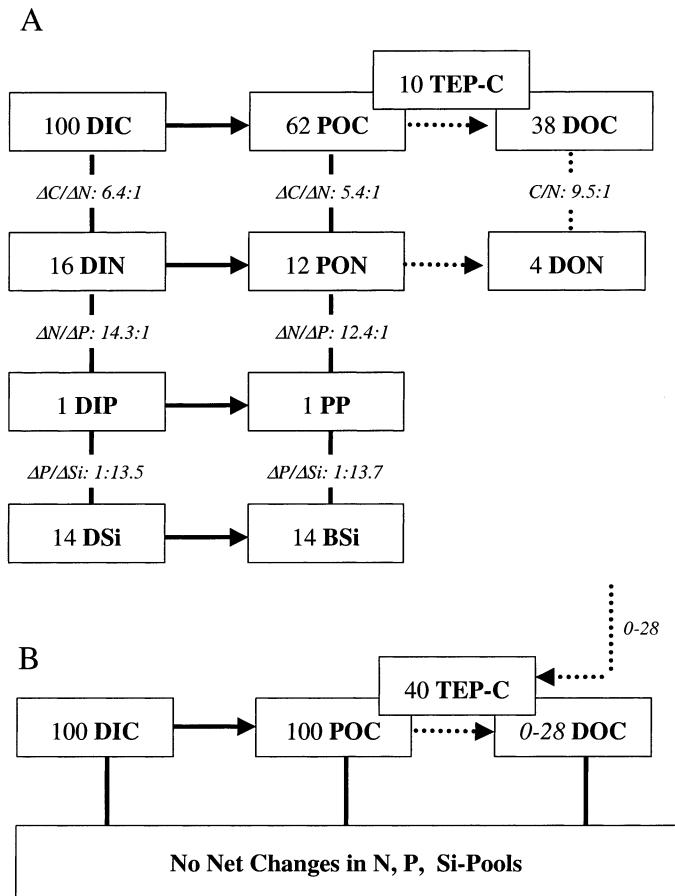

Fig. 10. (A) Molar element fluxes during the exponential (days 2–15) and (B) the nitrate-depleted phase (days 15–20) of the mesocosm bloom. Full lines indicate flows based on measurements; dotted lines indicate expected flows.

crease of 100 MU DIC was also concomitant with an increase of 10 MU of TEP-C. TEP are filterable particles and overlap to a certain, but unknown, degree with the POC pool. Because TEP originate from dissolved and colloidal organic matter, it must be assumed that the actual flow of carbon from the DIC into the POC pool was smaller than the reaction ratio indicated and that the POC pool was partly fueled from the DOC pool via TEP formation. Changes of DIC, DIN ($\text{NO}_3 + \text{NH}_4$), DIP (PO_4), and DSi ($\text{Si}(\text{OH})_4$) were directly proportional and followed a molar ratio of C:N:P:Si of 100:16:1:14. Thus the assimilation efficiency from the dissolved inorganic pools into the respective particulate organic pools increased in the order C, N, P, Si.

During the nitrate-depleted phase, only the relationships between DIC, POC, and TEP-C were significant ($p < 0.001$, Fig. 10B). At this time the increase of POC was approximately equal to the decrease in DIC. TEP production explained 40% of DIC decrease. If we, again, assume that a significant fraction of TEP-C is included in POC, then the direct flow of DIC into POC must have been much smaller in the postbloom phase. Because the TEP pool may also have been fueled from DOC exuded during the exponential phase, only the upper and lower limits of carbon entering

Table 1. Molar concentration ratios of particulate elements in marine snow sampled from the mesocosm.

Day	TEP-C:POC	POC:PON	PON:PP	PP:BSi
16	0.31	8.6	20.9	0.022
17	0.16	9.4	34.9	0.020
18	0.28	10.1	41.6	0.022
19	0.11	10.6	89.0	0.020
20	0.11	12.4	17.2	0.034

the DOC pool can be estimated. Since the POC pool increased significantly but PON remained unchanged, the theoretical assimilation ratio of C:N into POM was infinitely high during the postbloom phase.

Marine snow—Visible aggregates (marine snow) occurred on day 16. Elemental composition of particles contained in marine snow was determined from day 16 to day 20 (Table 1). TEP-C concentration was equal to about 11–31% of POC concentration. The relationship between TEP-C and POC was significant ($r^2 = 0.82$, $p < 0.005$). Concentration ratios of POC and PON increased with time and approached the POC:PON ratio of bulk particles on day 20. PON:PP ratios were significantly higher in marine snow than in the bulk particle fraction, which indicates rapid release of phosphorus. Accordingly, PP:BSi ratios were lower than the bulk ratios.

Discussion

Allredge et al. (1995) examined the aggregation of a diatom-dominated bloom in a similar mesocosm experiment. Although initial nutrient concentrations were higher, the development of TEP, POC, and PON concentrations during the 1995 bloom agrees with the present study: after nitrate depletion, POC and TEP continued to increase, whereas PON decreased slightly, giving rise to an elevation of the POC:PON ratio. The present study explores in detail the temporal changes in the flows of the major biogeochemical elements C, N, P, and Si and investigates the role of TEP for the decoupling of carbon and nitrogen dynamics and the potential export of overconsumed carbon by sinking aggregates.

Elemental stoichiometry—Tight covariation and reciprocal interaction of nutrient elements, as suggested from the Redfield concept, were observed as long as nutrient concentrations were replete. Thus, the proportionality of C, N, and P uptake was in rather good accordance with the Redfield ratio, while the assimilation ratios of these elements into POM were slightly different. POC production during the growth phase accounted for only 62% of the net DIC uptake not corrected for carbon included in TEP. There was a higher release of DOC compared to DON. The resulting relative nitrogen enrichment observed in the POM is typical for marine phytoplankton growing at high DIN concentrations. For DOC production it can be assumed that heterotrophic activities such as bacterial degradation, sloppy feeding by microzooplankton, or viral lysis were of minor importance, since dark respiration rates at that time were negligible. Instead,

direct release of DOC from the autotrophic cells due to passive leakage and/or active exudation as observed repeatedly in phytoplankton cultures is a more likely DOC source. Estimates of extracellular release from phytoplankton vary from <5% to >50% of primary production, with the higher values observed in experimental systems (e.g., Biddanda and Benner 1997). Mean ecosystem values lie between 3% and 40% (Baines and Pace 1991). Formation of TEP accounted for only a minor fraction of carbon during nitrate-replete growth. TEP contain acidic polysaccharides that are also observed in phytoplankton exudates, especially in the high molecular weight fraction (Alluwihare et al. 1997). Exudation of these high molecular weight (>1,000 Da) carbohydrates is small during exponential growth of phytoplankton (Eberlein and Brockmann 1986), which may explain low TEP formation at these times.

Decoupling of carbon dynamics from nitrogen and phosphorus was observed after nitrate depletion. During the nitrate-depleted phase net community production and POC production were almost as high as during the exponential phase, leading to a doubling of POC:PON ratios. Increase of POC:PON ratios under nitrogen deficiency has been observed frequently during experimental studies (e.g., Antia et al. 1963; Biddanda and Benner 1997) and in the field (Daly et al. 1999) and has been attributed to preferential PON degradation or intracellular increase of the C:N ratio. During our study, POC:PON clearly increased because of excess-carbon fixation. A significant fraction of carbon (40%) was channeled into the extracellular particles pool (i.e., TEP). Increase of TEP formation at the end of phytoplankton blooms has been observed in the field (Logan et al. 1995; Mari and Kjørboe 1996) as well as in experimental systems (Engel 2000) and has been attributed to nutrient, especially nitrogen, depletion (Corzo et al. 2000). Release of high molecular weight carbohydrates has been observed to be much higher under nutrient limitation than during exponential growth (Penna et al. 1999). Thus, the quantity of TEP precursors delivered by phytoplankton exudation was presumably also enhanced during the nitrate-depleted phase of this experiment. Net increase of the POC pool after day 15 was equal to net community production. It is therefore assumed that DOC production, other than TEP precursors, was rapidly respired by the increasing heterotrophic community.

Marine snow formation and composition—Marine snow occurred in the mesocosm shortly after nutrient exhaustion and was sampled during the postbloom phase. It has been shown that TEP are largely responsible for aggregate formation in natural plankton communities (Logan et al. 1995; Engel 2000), and a tight and fast coupling of nutrient exhaustion, elevated TEP production, and marine snow appearance was also observed here. Although aggregates in the mesocosm were resuspended artificially by stirring, they would likely sink out from the upper mixed layer in the sea. Thus, aggregates that were sampled on day 16 and 17 may have been more similar to fresh aggregates leaving the upper mixed layer, whereas those sampled on days 18–20 may have been more representative of aged aggregates. Elemental composition of marine snow differed from the Redfield ratio by an enrichment in carbon and a depletion of phosphorus

Table 2. Carbon overconsumption calculated as carbon taken up or contained in the different elemental pools in excess of the expected value ($\Delta N \times 6.6$) during the whole study (days 2–20) and up to the day of marine snow occurrence (day 16). C and N contained in TEP were calculated assuming a C:N ratio of 26, after Engel and Passow (2001).

	ΔN ($\mu\text{mol L}^{-1}$)	ΔC ($\mu\text{mol L}^{-1}$)	C:N (M:M)	$\Delta N \times$ 6.6 ($\mu\text{mol L}^{-1}$)	Excess C	
					($\mu\text{mol L}^{-1}$)	%
Days 2–20						
Uptake	35	397	11	231	166	72
POM	29	356	13	191	165	86
DOM	6	41	6.8	40	1	2.5
TEP	3.8	98	26	25	73	292
Days 2–16						
Uptake	35	273	7.8	231	42	18
POM	28	218	7.8	185	33	14
DOM	7	55	7.9	46	9	20
TEP	1.2	31	26	7.9	23	292

relative to nitrogen. Thus, the POC:PON ratios were similar to sediment trap material observed in the field. Degradation of PP is processed by the enzyme alkaline phosphatase, whose activities are usually higher in aggregates than in the suspended particle fraction (Smith et al. 1992). Low proportions of PP in marine snow were therefore most likely due to preferential remineralization, which is reflected in increasing N:P ratios with time. Carbon enrichment in freshly formed aggregates can be explained by agglutination with carbon-rich TEP, while the high C:N ratios of aggregates observed on days 19 and 20 may also be due to differential use of nitrogen.

Implications for biochemical fluxes in the ocean—In the ocean, the uptake of more DIC than inferred from nitrate supply and Redfield stoichiometry is referred to as carbon overconsumption (Toggweiler 1993). Estimates of carbon overconsumption in the field vary between 17 and 300% (Sambrotto et al. 1993; Michaels et al. 1994; Marchal et al. 1996). Aside from a large biological variability between the ecosystems studied, accurate estimates of carbon uptake and fate in the field are difficult, due to advection of dissolved and particulate elements and export of elements contained in sinking particles. Experimental systems, such as the mesocosm used in this study, are artificial and preclude many natural abiotic and biotic factors, like the sinking of cells and aggregates and the presence of zooplankton. Nevertheless, they contain complex communities where elemental flows can be traced and budgets calculated.

About 72% carbon overconsumption occurred during this mesocosm study, largely during the postbloom phase, and the excess carbon was almost entirely traced to the POM pool (Table 2). This showed that net carbon uptake can continue under nitrate depletion for a significant time. Carbon overconsumption up to the day of marine snow formation (18%, Table 2) in the mesocosm was smaller than the overall estimate and comparable to the lower in situ estimates. As-

suming that TEP have a mean C:N ratio of 26 (Engel and Passow 2001), the major part of excess carbon at the onset of marine snow formation was contained in TEP. If all of the TEP-C was part of the POC, the C:N ratio of solid particles at that time was theoretically only 7.2 instead of 8.1 for bulk POC, including TEP (Fig. 9). TEP are gel particles that do not sink at significant velocities until contained in aggregates. The aggregation of TEP with sinking particles can therefore be a possible and efficient mechanism for the export of excess carbon.

The formation and sedimentation of aggregates toward the end of diatom blooms is frequently observed in the field. Assuming that the mesocosm scenario can be representative for a phytoplankton bloom that develops in the euphotic zone after the intrusion of nutrient-rich deep water, we can estimate how efficiently sinking aggregates may export overconsumed carbon. Largely due to TEP, the freshly formed marine snow on day 16 showed a selective enrichment of carbon, with a C:N ratio of 8.6. At this time 14% of the $218 \mu\text{mol POC L}^{-1}$ was excess carbon, equal to $33 \mu\text{mol POC L}^{-1}$ (Table 2). From the $35 \mu\text{mol DIN L}^{-1}$, initially supplied as nitrate, $218 \times 35/8.6 = 0.72$, i.e., 72% needed to be exported through sinking aggregates in order to export the excess carbon. The highest C:N ratio of 12.4 observed for marine snow later during the postbloom would, of course, export excess carbon more efficiently. In this case, the complete export of all of the excess carbon that was assimilated into POM during the whole study would require the sedimentation in aggregates of 82% of nitrogen initially supplied as nitrate.

In many natural systems heterotrophs diminish the population of nutrient starved phytoplankton toward the end of the bloom. This will restrict the assimilation and exudation of excess carbon as well as the formation of aggregates during the postbloom. Grazers may also reduce the export flux by aggregate breakup and degradation. Thus, heterotrophic activity presumably has the potential to control the extent of carbon overconsumption and the resulting increase of C:N ratios above the Redfield ratio.

Nevertheless, there are numerous oceanic regions where blooms are dominated by diatoms experiencing low grazing pressure and terminated by aggregation. Here, the majority of export production is by settling aggregates (e.g., Fowler and Knauer 1986) and may correspond with our estimates for N export in aggregates. We advocate quantitative evaluations of aggregate export in the field, since the results of this study indicate that aggregates can mediate the export of carbon above calculations that are based on the Redfield stoichiometry.

References

- ALLDREDGE, A. L., AND C. C. GOTSCHALK. 1989. Direct observations of the mass flocculation of diatom blooms: Characteristics, settling velocities and formation of diatom aggregates. *Deep-Sea Res.* **36**: 159–171.
- , ———, U. PASSOW, AND U. RIEBESELL. 1995. Mass aggregation of diatom blooms: Insights from a mesocosm study. *Deep-Sea Res. II* **42**: 9–27.
- , U. PASSOW, AND B. E. LOGAN. 1993. The abundance and significance of a class of large, transparent organic particles in the ocean. *Deep-Sea Res.* **40**: 1131–1140.
- ALLUWIHARE, L. I., D. J. REPETA, AND R. F. CHEN. 1997. A major biopolymeric component of dissolved organic carbon in surface seawater. *Nature* **387**: 166–169.
- ANTIA, N. J., C. D. MCALLISTER, T. R. PARSONS, K. STEPHENS, AND J. D. H. STRICKLAND. 1963. Further measurements of primary production using a large-volume plastic sphere. *Limnol. Oceanogr.* **8**: 166–183.
- BAINES, S. B., AND M. L. PACE. 1991. The production of dissolved organic matter by phytoplankton and its importance to bacteria: Patterns across marine and freshwater systems. *Limnol. Oceanogr.* **36**: 1078–1090.
- BANSE, K. 1994. Uptake of inorganic carbon and nitrate by marine plankton and the Redfield ratio. *Glob. Biogeochem. Cycles* **8**: 81–84.
- BIDDANDA, B., AND R. BENNER. 1997. Carbon, nitrogen, and carbohydrate fluxes during the production of particulate dissolved organic matter by marine phytoplankton. *Limnol. Oceanogr.* **42**: 506–518.
- BRZEZINSKI, M. A., AND D. M. NELSON. 1989. Seasonal changes in the silicon cycle within a Gulf Stream warm-core ring. *Deep-Sea Res.* **36**: 1009–1030.
- CORZO, A., J. A. MORILLO, AND S. RODRÍGUEZ. 2000. Production of transparent exopolymer particles (TEP) in cultures of *Chaetoceros calcitrans* under nitrogen limitation. *Aquat. Mar. Ecol.* **23**: 63–72.
- DALY, K. L., AND OTHERS. 1999. Non-Redfield carbon and nitrogen cycling in the Arctic: Effects of ecosystem structure and dynamics. *J. Geophys. Res.* **104**: 3185–3199.
- DUGDALE, R. C., AND J. J. GOERING. 1967. Uptake of new and regenerated forms of nitrogen in primary productivity. *Limnol. Oceanogr.* **12**: 196–206.
- EBERLEIN, K., AND U. H. BROCKMANN. 1986. Development of particulate and dissolved carbohydrates in parallel enclosure experiments with monocultures of *Thalassiosira rotula*. *Mar. Ecol. Prog. Ser.* **32**: 133–136.
- ENGEL, A. 2000. The role of transparent exopolymer particles (TEP) in the increase in apparent particles stickiness (α) during the decline of a diatom bloom. *J. Plankton Res.* **22**: 485–497.
- , AND U. PASSOW. 2001. The carbon and nitrogen content of transparent exopolymer particles (TEP) in relation to their Alcian Blue adsorption. *Mar. Ecol. Prog. Ser.* **219**: 1–10.
- EPPLEY, R. W., AND B. J. PETERSON. 1979. Particulate organic matter flux and planktonic new production in the deep ocean. *Nature* **282**: 677–680.
- FOWLER, S. W., AND G. A. KNAUER. 1986. Role of large particles in the transport of elements and organic compounds through the oceanic water column. *Prog. Oceanogr.* **16**: 147–194.
- HONJO, S., AND S. J. MAGANINI. 1993. Annual biogenic particle fluxes to the interior of the North Atlantic Ocean: Studied at $34^{\circ}\text{N } 21^{\circ}\text{W}$ and $48^{\circ}\text{N } 21^{\circ}\text{W}$. *Deep-Sea Res. I* **40**: 587–607.
- JOHNSON, K. S., R. L. PETTY, AND J. THOMSEN. 1985. Flow injection analysis of seawater micronutrients. *Adv. Chem. Ser.* **209**: 7–30.
- KOROLEFF, F., AND K. GRASSHOF. 1983. Determination of nutrients, p. 125–188. *In* K. Grasshof, M. Erhardt, and K. Kremling [eds.], *Methods of seawater analyses*. Verlag Chemie.
- LAWS, E. A. 1991. Photosynthetic quotients, new production, net community production in the open ocean. *Deep-Sea Res.* **38**: 143–167.
- LEWIS, E., AND D. W. R. WALLACE. 1998. Program developed for CO₂ System Calculations. ORNL/CDIAC-105. Carbon Dioxide Information Analysis Center, Oak Ridge National Laboratory, U.S. Department of Energy.
- LOGAN, B. E., U. PASSOW, A. L. ALLDREDGE, H.-P. GROSSART, AND

- M. SIMON. 1995. Rapid formation and sedimentation of large aggregates is predictable from coagulation rates (half-lives) of transparent exopolymer particles (TEP). *Deep-Sea Res. II* **42**: 203–214.
- LOH, A. N., AND J. E. BAUER. 2000. Distribution, partitioning and fluxes of dissolved and particulate organic C, N and P in the eastern north Pacific and Southern Oceans. *Deep-Sea Res. I* **47**: 2287–2316.
- MARCHAL, O., P. MONFRAY, AND N. R. BATES. 1996. Spring-summer imbalance of dissolved inorganic carbon in the mixed layer of the northwestern Sargasso Sea. *Tellus* **48B**: 115–134.
- MARI, X., AND T. KIØRBOE. 1996. Abundance, size distribution and bacterial colonization of transparent exopolymeric particles (TEP) during spring in the Kattegat. *J. Plankton Res.* **18**: 969–986.
- MICHAELS, A. F., N. R. BATES, K. O. BUESSELER, C. A. CARLSON, AND A. H. KNAP. 1994. Carbon-cycle imbalance in the Sargasso Sea. *Nature* **372**: 537–540.
- PARSONS, T. R., Y. MAITA, AND C. M. LALLI. 1984. A manual of chemical and biological methods for seawater analysis. Pergamon.
- PASSOW, U. 2000. Formation of transparent exopolymer particles, TEP, from dissolved precursor material. *Mar. Ecol. Prog. Ser.* **192**: 1–11.
- , AND A. L. ALLDREDGE. 1994. Distribution, size and bacterial colonization of transparent exopolymer particles (TEP) in the ocean. *Mar. Ecol. Prog. Ser.* **113**: 185–198.
- , AND ———. 1995. A dye-binding assay for the spectrophotometric measurement of transparent exopolymer particles (TEP) in the ocean. *Limnol. Oceanogr.* **40**: 1326–1335.
- PENG, T. H. T., W. S. TAKAHASHI, W. S. BROECKER, AND J. OLAFSON. 1987. Seasonal variability of carbon dioxide, nutrients and oxygen in the North Atlantic surface water: Observations and a model. *Tellus* **39B**: 439–458.
- PENNA, A., S. BERLUTI, N. PENNA, AND M. MAGNANI. 1999. Influence of nutrient ratios on the in vitro extracellular polysaccharide production by the marine diatoms from the Adriatic Sea. *J. Plankton Res.* **21**: 1681–1690.
- REDFIELD, A. C., B. M. KETCHUM, AND F. A. RICHARDS. 1963. The influence of organism on the composition of seawater, p. 26–77. *In* M. N. Hill [ed.], *The sea*. Wiley.
- SAMBROTTO, R. N., AND OTHERS. 1993. Elevated consumption of carbon relative to nitrogen in the surface ocean. *Nature* **363**: 248–250.
- SHARP, J. H. 1992. Total mass and particulate carbon, nitrogen and phosphorous, p. 87–91. *In* D. C. Hurd and D. W. Spencer [eds.], *Marine particles: Analysis and characterization*. Geophysical Monographs 63. American Geophysical Union.
- SMITH, D. C., M. SIMON, A. L. ALLDREDGE, AND F. AZAM. 1992. Intense hydrolytic enzyme activity on marine aggregates and implications for rapid particle dissolution. *Nature* **359**: 139–141.
- TOGGWEILER, J. R. 1993. Carbon overconsumption. *Nature* **363**: 210–211.

Received: 15 May 2001
Accepted: 4 December 2001
Amended: 25 January 2002