

Nearshore circulation during upwelling inferred from the distribution of dissolved cadmium off the Oregon coast

Renee K. Takesue

Department of Earth and Environmental Sciences, Columbia University, New York, New York 10027

Alexander van Geen

Lamont-Doherty Earth Observatory of Columbia University, Route 9W, Palisades, New York 10964

Abstract

The effectiveness of dissolved cadmium (Cd) as a tracer of coastal upwelling is demonstrated by comparing its water column distribution to that of traditional upwelling indicators, in particular phosphate (P) and salinity, as well as equatorward wind forcing at the Oregon coast. Cd and P concentrations in samples collected on board ship on 17–27 August 1995 between 3 and 100 km from the coast offshore of Cape Blanco, Oregon, ranged between 0.2 and 0.9 nmol kg⁻¹ and <0.1 and 2.5 μmol kg⁻¹, respectively. Both tracers behaved conservatively during onshore transport at depth; linear Cd-salinity and P-salinity relations in offshore source waters were preserved in bottom waters over the shelf. Following upwelling to the surface, however, Cd and P distributions diverged, with Cd remaining essentially constant while P was taken up by phytoplankton, predominantly diatoms. The Cd content of nearshore water collected from the beach inshore of the cruise area was very similar to that of upwelling source waters sampled from the ship, suggesting efficient exchange of waters between the shelf bottom layer and the very nearshore region, including the surfzone. A simple box model, in which onshore Ekman transport occurs through a well-mixed bottom layer extending from the edge of the continental shelf to the very nearshore region, illustrates a close link between upwelling-favorable wind forcing and very nearshore Cd concentrations. The close agreement between Cd time series generated by the model and surfzone Cd sampled every 2–4 weeks during 1994–1996 suggests that the effectiveness of Cd as a tracer of wind-driven coastal upwelling off the Oregon coast is due in large part to conveyor-like circulation and the remarkably efficient mixing of newly upwelled water into the very nearshore region.

Eastern boundary currents such as the California Current system are among the most productive waters in the world ocean (Ryther and Dunstan 1969; Chavez and Toggweiler 1995). While a complex set of factors regulate productivity in the California Current (Abbott and Barksdale 1991; Chavez et al. 1991; Mann 1993), the supply of nutrient-rich water by coastal upwelling undoubtedly plays an important role. Coastal upwelling is particularly intense at midlatitudes along the northwestern U.S. coast during spring and summer because the gradient between warm air temperatures (low atmospheric pressure) over the central valley of California and comparatively cool temperatures (high atmospheric pressure) over the coastal ocean drives strong equatorward upwelling-favorable winds (Huyer 1983; Beardsley et al. 1987; Bakun and Nelson 1991). By using the trace element cadmium as a tracer of nearshore circulation, the present study provides a new perspective on the relation between

wind forcing and the supply of nutrients during upwelling off the Oregon coast.

Van Geen et al. (1992) and van Geen and Husby (1996) first showed that variations in the dissolved Cd content of surfzone waters were related to alongshore wind forcing at a number of sites along the northwestern U.S. coast. The sensitivity of Cd to coastal upwelling is due to a pronounced vertical gradient in offshore concentrations that is maintained by biological uptake in surface waters and remineralization at depth, much in the way vertical concentration gradients are maintained for phosphate and other nutrients (Martin et al. 1976; Boyle et al. 1976; Bruland 1980; Knauer and Martin 1981). The objective of this paper is to show from observations off the Oregon coast during 1994–1996 that Cd, unlike other surface water properties such as temperature, salinity, or nutrient concentrations, is essentially a conservative tracer of coastal upwelling over a several-day period. This unique characteristic of Cd is then used to infer a pattern of cross-shelf circulation that demonstrates the importance of the bottom boundary layer in determining the composition of very nearshore waters during upwelling.

Methods

Shipboard sample collection—The ship-based component of this study was conducted aboard the RV *Wecoma* on 17–27 August 1995 offshore of Cape Blanco, Oregon. Physical observations and carbon and nutrient data collected during this cruise were previously reported by Barth et al. (2000)

Acknowledgments

We thank Jack Barth and Bob Smith for allowing us to participate in their August 1995 RV *Wecoma* cruise; Pat Wheeler for the use of deck incubators; Stefan Petranek for cruise preparation and diatom counting; Lloyd Burkle for assistance in diatom identification; Laura Verhegge for assistance in collecting and processing surfzone samples; the Oregon Institute of Marine Biology for providing lab space; and Bill Landing for supplying the 8-hydroxyquinoline resin. This study was supported by U.S. National Science Foundation grant OCE94-02372 as well as U.S. Office of Naval Research grants N00014-94-1-0618 and N00014-95-1-0477. This is LDEO contribution 6231.

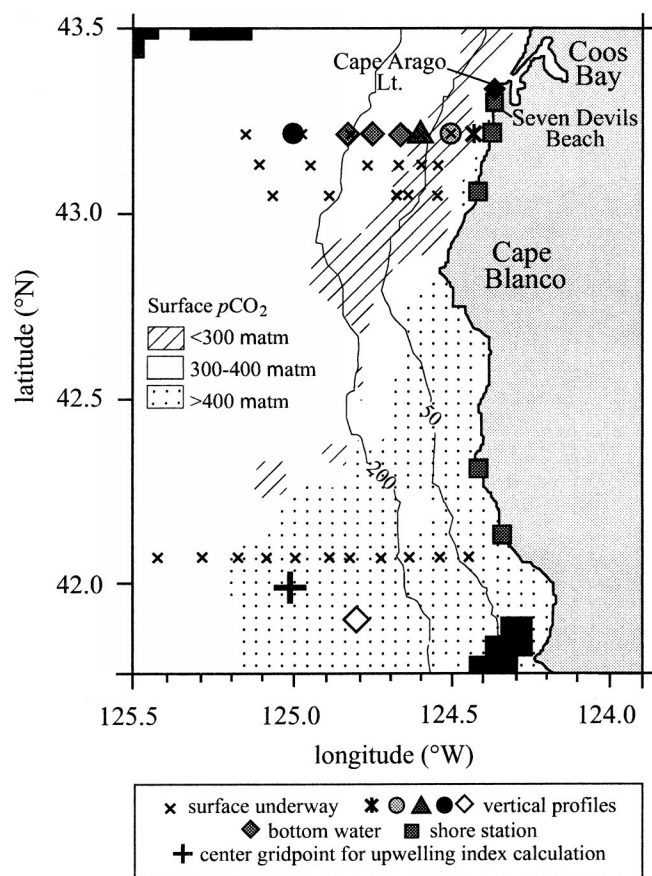

Fig. 1. Locations where ship-based underway water samples, water column profiles, bottom water samples, and shore station surf-zone samples were collected. Wind measurements at the Cape Arago Lighthouse and the upwelling index at 42°N , which is an estimate of offshore Ekman transport calculated from synoptic surface pressure measurements, were used to derive local and large-scale wind stress, respectively. Surface $p\text{CO}_2$ values are averages for the period 17–19 August 1995. Black regions indicate no data. The 50 and 200 m depth contours are shown.

and van Geen et al. (2000). In August 1995, an equatorward jet following the 15°C surface isotherm marked an upwelling front that shifted from a position 15 km from the coast north of Cape Blanco to a position 75 km from the coast south of Cape Blanco (Barth et al. 2000). This upwelling front divided the nearshore region into three distinct hydrographic regimes. Offshore of the front, surface waters were warm (17°C), close to equilibrium with the atmosphere ($300 < p\text{CO}_2 < 400 \mu\text{atm}$; Fig. 1), and depleted in nutrients. Inshore of the front south of Cape Blanco, surface waters were extremely cold (9°C), supersaturated ($p\text{CO}_2 > 400 \mu\text{atm}$) relative to the atmosphere (Fig. 1), and enriched in nutrients due to recent upwelling. In contrast, inshore of the front north of Cape Blanco, surface waters were cold (12°C) but undersaturated ($p\text{CO}_2 < 300 \mu\text{atm}$) relative to the atmosphere (Fig. 1) and extremely depleted in nutrients due to a strong phytoplankton bloom (van Geen et al. 2000).

Discrete surface water samples were collected underway on 19–21 August for Cd, nutrients, and salinity along three cross-shore transects north of Cape Blanco extending from

3 to 56 km from the coast and one transect south of Cape Blanco extending from 7 to 102 km from the coast (Fig. 1). Surface waters were continuously pumped to the shipboard laboratory through a trace metal-clean sampling system described by Boyle et al. (1982). Discrete samples were collected from the continuous flow in an acid-cleaned Teflon sampling vessel placed within a Class-100 laminar flow bench. In addition to underway surface samples, four water column profiles were collected on 18–19 August with acid-cleaned Niskin bottles on a CTD-Rosette along the transect at 43.2°N : a northern deep-water profile 46 km offshore over the upper slope and three shallow water profiles over the shelf at distances of 4, 8, and 15 km from the coast (Fig. 1). In addition, subsurface samples were collected within 20 m of the bottom at distances of 21, 27, and 33 km from the coast, respectively. On 21 August a southern deep-water column profile was collected near the southernmost transect (41.9°N), 40 km offshore of Crescent City, California.

Shipboard incubation experiment—At the location of the southern deep-water profile (41.9°N), three 10-liter acid-cleaned polyethylene cubitainers were filled with unfiltered water from 40 m depth, the location of the chlorophyll maximum, and placed in a Plexiglas incubator on the ship's deck. The incubator was covered with two layers of screening to reduce incident light and flushed continuously with surface water ($9\text{--}18^{\circ}\text{C}$). Sixty-milliliter sample aliquots for nutrient and trace metal analyses were drawn daily from each cubitainer and filtered through $0.4\text{-}\mu\text{m}$ Nuclepore® filters. Twenty-milliliter sample aliquots for plankton identification and counting were drawn daily and stored in a 4% glutaraldehyde solution for up to 9 months (Taylor 1976).

Collection of surfzone water (1994–1996)—Surfzone water collection began in late March 1994 at Seven Devils Beach (43.4°N), 50 km north of Cape Blanco, Oregon (Fig. 1). Over a 3-yr period, water samples were collected twice a month during the upwelling season (March–August) and once a month from September to February. Samples were processed at the Oregon Institute of Marine Biology in the manner described by van Geen and Husby (1996). All samples were stored at room temperature for up to 2 yr until analysis. Surfzone samples collected 26–27 August 1995 (Fig. 1), 1 week after the ship-based sampling, were processed in the same manner. Sample locations are given in Web Appendix 1 at <http://www.aslo.org/lo/toc/vol-47/issue-1/0176a1.pdf>.

Analyses—Dissolved Cd determinations were made by graphite-furnace atomic absorption spectroscopy (GFAAS), following preconcentration. At least 1 d before analysis, surfzone Cd samples were acidified to 0.1% by volume 12 N HCl (Seastar Chemicals). Surfzone samples collected between March 1994 and August 1995 were analyzed using the methods described by van Geen and Husby (1996). Surfzone samples collected between August 1995 and December 1996 were analyzed using the same preconcentration chemistry, scaled down to process a 0.5-ml sample through a $75\text{-}\mu\text{l}$ resin column placed in-line with the autosampler of a Hitachi Z8200 GFAAS instrument. The syringe pump and

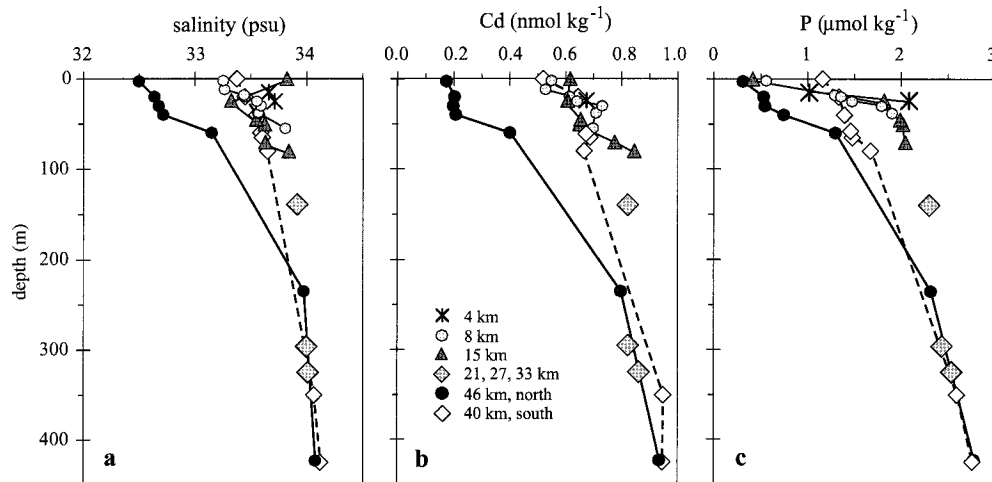

Fig. 2. Water column profiles of (a) salinity, (b) Cd, and (c) P collected along cross-shore transects at 43.2°N on 18–19 August 1995 and at 41.9°N on 21 August 1995.

the autosampler's three-way valve, both controlled by an external stepping motor, were used to load the sample onto the resin, rinse the resin column with a buffer solution, and elute the concentrate directly into the graphite tube for analysis. Samples collected during the August 1995 field program were preconcentrated using the same approach, although the resin column was changed to 15 μl of 8-hydroxyquinoline (Landing et al. 1986). Both in-line methods were calibrated by including consistency standards containing 0.1 and 1.2 nmol kg^{-1} Cd with each run. The Cd content of the low-Cd consistency standard was determined relative to a sample of warm surface water from 19°N, 113°W (offshore of Baja California) assumed to contain no Cd. The reproducibility of the in-line procedure was $\pm 5\%$ for samples containing 0.2–1.0 nmol kg^{-1} Cd.

P, Si, and N concentrations for the incubations and the surfzone time series were measured in the laboratory by standard colorimetry (Strickland and Parsons 1968) using a Lachat QuikChem 8000 flow-injection analyzer. Detection limits were 0.1, 0.2, and 0.1 $\mu\text{mol kg}^{-1}$ for P, Si, and N, respectively (van Geen et al. 2000). Salinity was measured on a Guildline salinometer calibrated with IAPSO (International Association for Physical Science of the Ocean) standard seawater.

Wind-forcing estimates—Estimates of large-scale and local alongshore wind forcing during 1994–1996 were calculated in two different ways. The Daily upwelling index produced by the Pacific Marine Fisheries Environmental Laboratory (<http://www.pfeg.noaa.gov>) was used to estimate large-scale alongshore wind stress. To derive the daily values, 6-hourly surface pressure measurements are interpolated over a 3° grid centered at 42°N, 125°W (Fig. 1) and used to calculate a geostrophic wind, which is rotated 15° counterclockwise and reduced 30% to account for frictional effects at the surface. Alongshore wind stress (dynes cm^{-2}) is calculated as $\tau_y = \rho_a C_d |\mathbf{v}| \mathbf{v}$, where $\rho_a = 0.00122 \text{ g cm}^{-3}$, a constant density of air; $C_d = 0.0013$, a constant nondimensional drag coefficient; \mathbf{v} is the alongshore velocity compo-

nent of the geostrophic wind (cm s^{-1}); and $|\mathbf{v}|$ is the magnitude of the alongshore wind (cm s^{-1}) (Bakun 1975). Ekman mass transport ($\text{m}^3 \text{ s}^{-1}$ per 100 m coastline) is then calculated from $U = (\tau_y \times \mathbf{k}) f^{-1}$, where \mathbf{k} = a unit vector directed upward and f = the Coriolis parameter, which is dependent on latitude (Bakun 1975). To facilitate comparisons with local wind-forcing estimates, the daily upwelling indices were converted to alongshore stress (dynes cm^{-2}) using the same values. Local forcing during 1994–1996 was estimated from wind measurements at the Cape Arago lighthouse (Station CARO3 of the Coastal Marine Automated Network), 10 km north of Seven Devils Beach (Fig. 1). The anemometer of this lighthouse, which stands on a bluff 18 m above sea level, is located 15 m above ground. Wind stress was calculated from the hourly alongshore component of the wind and the same values for ρ_a and C_d used to calculate the upwelling indices, then averaged to a daily value.

Results

Water column profiles—The two deep-water column profiles (Fig. 1) constrain the composition of source waters for coastal upwelling. Between ~ 250 and 450 m, water column properties were similar at both sites, with small increases in salinity (33.9 to 34.1), Cd (0.8 to 0.9 nmol kg^{-1}), and P (2.5 to 3.0 $\mu\text{mol kg}^{-1}$) with depth (Fig. 2, Web Appendix 1). The Cd to P ratio of source waters below 200 m obtained by least squares regression was $0.33 \times 10^{-3} \text{ mol mol}^{-1}$ (Fig. 3a), similar to the average for northeast Pacific subsurface waters (Bruland 1980). Above 250 m, the water column composition was very different at the two stations, in agreement with the contrasting hydrography of the two regions. North of Cape Blanco (offshore of the upwelling front), Cd and P concentrations decreased toward surface minima of 0.2 nmol kg^{-1} and 0.3 $\mu\text{mol kg}^{-1}$, respectively, while retaining the Cd/P ratio of deeper waters (Fig. 2, Fig. 3a, Web Appendix 1). South of Cape Blanco (inshore of the upwelling front), however, surface Cd and P concentrations were over 2.5 and 4 times higher, respectively, than in the northern

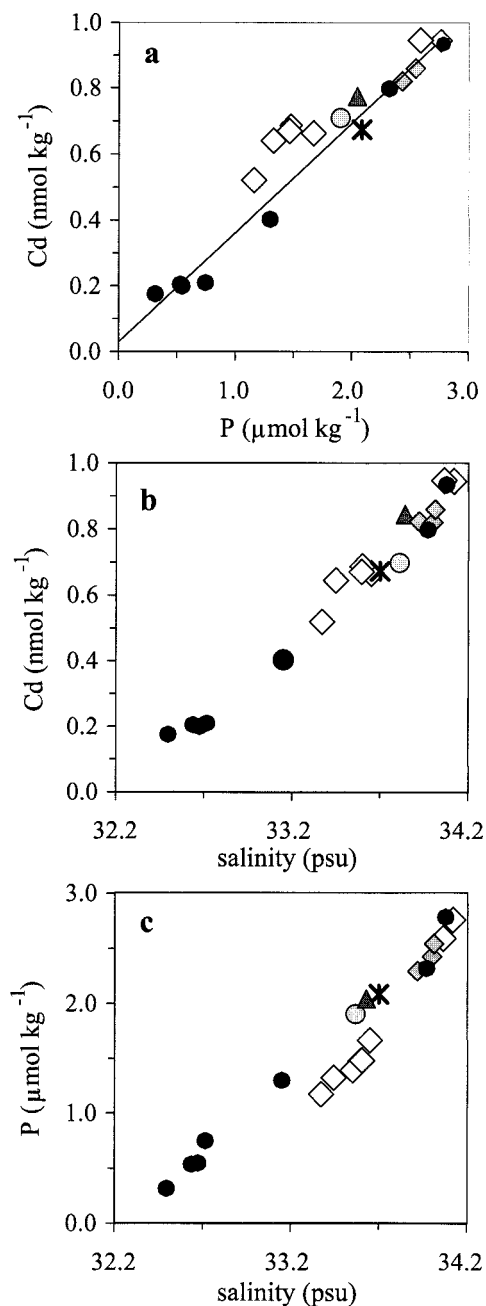

Fig. 3. (a) Linear least squares regression of Cd and P using all data below 200 m; $Cd = (0.33 \times 10^{-3}) (P) + 0.03$; $r^2 = 0.82$. Data from shallower depths of the northern and southern deep-water profiles are overlaid. Symbols as indicated in Fig. 2. (b) Cd-salinity and (c) P-salinity plots for data from all depths of the northern and southern deep-water profiles and shelf bottom waters. Symbols as indicated in Fig. 2.

region, and Cd/P ratios were somewhat higher than at depth (Fig. 3a). A comparison of Cd-salinity and P-salinity relationships at the southern site (Fig. 3b,c) suggests that elevated Cd/P ratios in surface waters were caused by a draw-down of P rather than an addition of Cd.

Further inshore over the continental shelf, salinity, Cd, and P concentrations also generally increased with depth, reach-

ing 34.0, 0.9 nmol kg⁻¹, and 2.5 μmol kg⁻¹, respectively, in near-bottom waters (Fig. 2, Web Appendix 1). Cd concentrations in three surfzone samples (0.8 nmol kg⁻¹) collected at 42.1°, 43.1°, and 43.2°N were remarkably similar to that of bottom water across the shelf. Data are available in Web Appendix 2 at http://www.aslo.org/lo/toc/vol_47/issue_1/0176a2.pdf. Surfzone P concentrations (0.7–2.1 μmol kg⁻¹) and salinities (32.62–33.66) in surfzone water collected from the three beaches, on the other hand, were somewhat lower than in bottom waters over the shelf (Web Appendix 2).

Surface transects—South of Cape Blanco, surface properties indicate that the region of active coastal upwelling extended from the coast to a distance of 40 km from shore. Newly upwelled water is readily identified by sea surface temperature (SST) < 9°C and $pCO_2 > 350 \mu atm$ (van Geen et al. 2000). In this region, surface Cd/P ratios only slightly higher than in source waters offshore ($0.39 \times 10^{-3} \text{ mol mol}^{-1}$; Fig. 4f–j) suggest that Cd and P concentrations were only slightly affected by biological uptake. North of Cape Blanco, the cross-shelf distributions of upwelling tracers show a pattern that is consistent with coastal upwelling in a narrow band adjacent to the coast (Fig. 4, Web Appendix 2). Surface Cd concentrations increased shoreward, from 0.2 nmol kg⁻¹ offshore of the upwelling front to as high as 0.8 nmol kg⁻¹ in the surfzone (Fig. 4d). Parallel increases in sea surface salinity (SSS) and decreases in SST indicate the presence of cold, salty subsurface water inshore of the upwelling front and in the surfzone (Fig. 4a,b). Surface P concentrations also increased toward shore; however, P levels did not rise significantly above 0.5 μmol kg⁻¹ until ~8 km from the coast (Fig. 4e). The region between 8 and 15 km from the coast where SSS, SST, and Cd concentrations indicate upwelling but P remains low corresponds to the location of a strong phytoplankton bloom that caused pCO_2 levels to become undersaturated relative to the atmosphere (Figs. 1 and 4c).

Shipboard incubation—The incubation experiment provides further evidence of decoupling between Cd and P uptake during diatom growth in recently upwelled water. Initial Cd and P concentrations in the three cubitainers were $0.54 \pm 0.03 \text{ nmol kg}^{-1}$ and $1.32 \pm 0.02 \mu\text{mol kg}^{-1}$, respectively (Fig. 5). The initial P concentration in the cubitainers was similar to that of water at 40 m depth sampled at the same location, although the initial Cd concentration in the cubitainers was lower than the 0.88 nmol kg⁻¹ concentration measured in a sample from the same depth collected directly from a Niskin bottle (Web Appendix 1). The difference suggests that some Cd may have adsorbed onto the cubitainer walls early in the experiment. By the fourth day of the incubation, P was depleted to $< 0.1 \mu\text{mol kg}^{-1}$ as the concentration of diatoms, predominantly *Coscinodiscus* sp. and *Chaetoceros* sp., increased rapidly (Fig. 5a,b). In contrast, Cd concentrations remained constant at 0.54 nmol kg⁻¹ in two cubitainers over the same period and decreased only slightly to 0.45 nmol kg⁻¹ in the third cubitainer (Fig. 5c). Had diatom Cd and P uptake occurred according to the average north Pacific subsurface Cd/P ratio, dissolved Cd con-

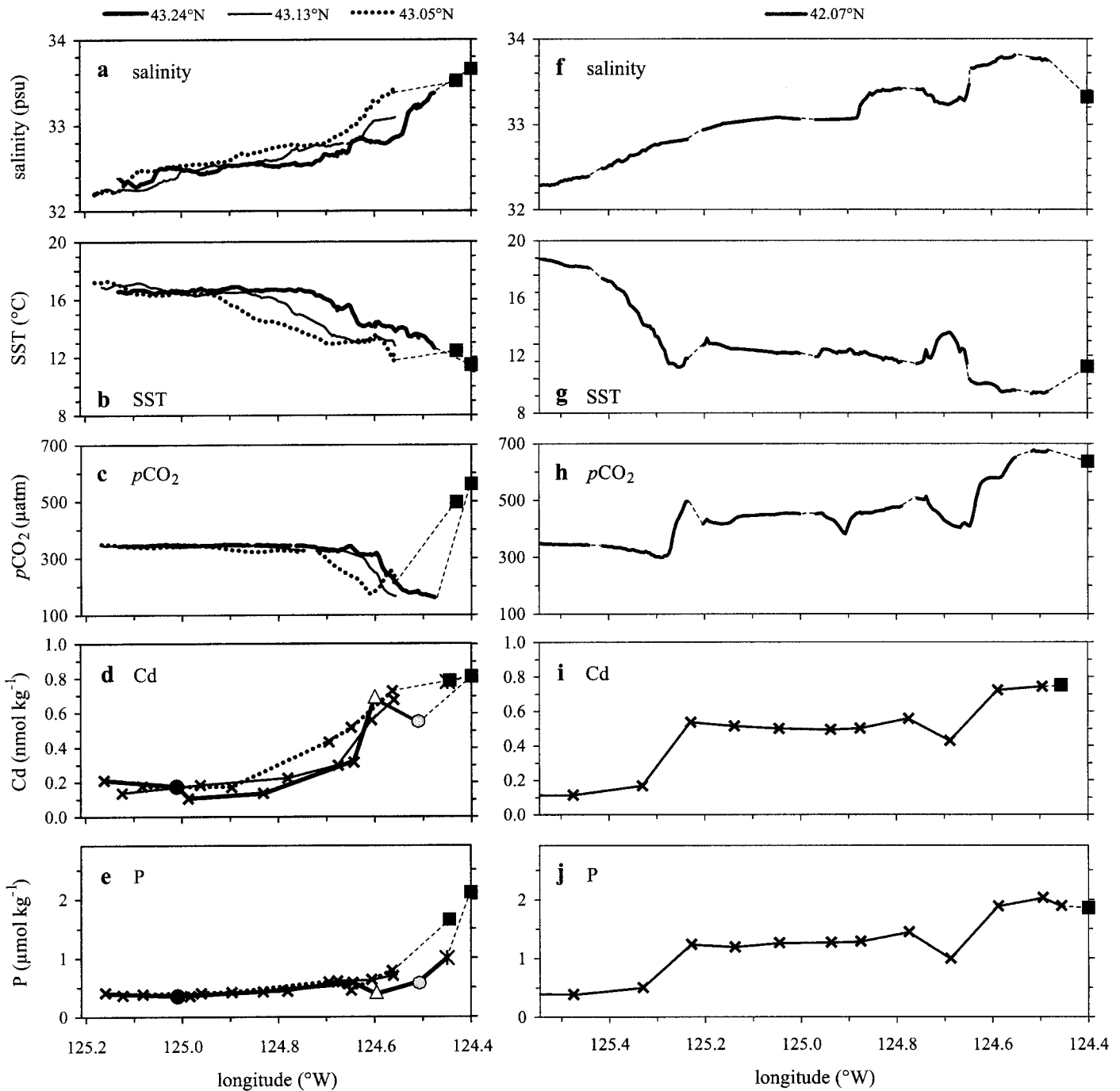

Fig. 4. Cross-shore surface transects of sea surface (a, f) salinity, (b, g) temperature, (c, h) $p\text{CO}_2$, (d, i) Cd, and (e, j) P sampled (a–e) north of Cape Blanco 18–19 August 1995 and (f–j) south of Cape Blanco 21 August 1995. Large squares indicate surfzone shore samples. Dashed lines between surfzone samples and offshore transects are interpolated. SSS and SST are from Barth et al. (2000); $p\text{CO}_2$ is from van Geen et al. (2000). Surfzone Cd in (i) comes from a beach at 42.31°N. To emphasize deviations from source water composition, the scales of the Cd and P axes are proportional to the global average subsurface Cd/P ratio (i.e., 1 nmol kg^{-1} Cd per 2.9 $\mu\text{mol kg}^{-1}$ P).

centrations would have decreased to <0.03 nmol kg^{-1} by the third day (Fig. 5c).

Five months after collection, diatom counts in concentrates of sample aliquots were several orders of magnitude lower than expected from previous studies of diatom blooms in the California Current (Chavez et al. 1991) and decreased further in concentrates prepared from two other cubitainers

9 months after collection. We attribute these unexpectedly low values to the apparent dissolution of siliceous frustules in the preservation medium (L. Burckle pers. comm.). Although our results probably underestimate the total number of cells in the incubation experiment, relative changes in population size (Fig. 5a) should not have been affected since the aliquots from each cubitainer were prepared together.

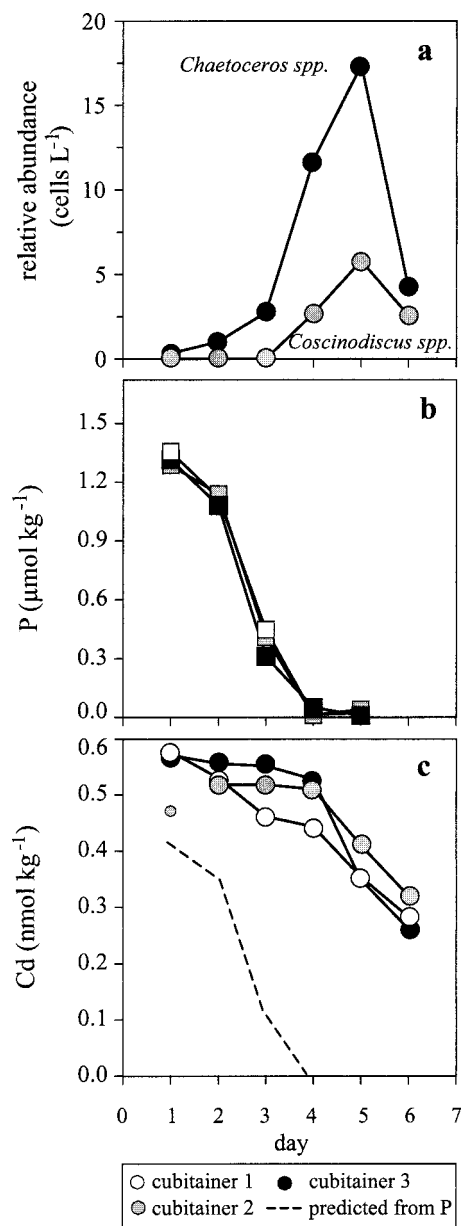

Fig. 5. Changes in (a) relative abundance of *Coscinodiscus* sp. and *Chaetoceros* sp. (as counted 5 months after preservation), (b) P, and (c) Cd during a ship-board incubation experiment. Predicted Cd in (c) was found using the Cd/P relation shown in Fig. 3 and measured P. The axes in (b) and (c) have been scaled as in Fig. 4.

Surfzone times series—Upwelling-favorable winds near Seven Devils Beach generally prevailed from May to September during the three sampling years and were accompanied by increases in nearshore Cd and P concentrations (Fig. 6). Surfzone Cd and P concentrations spanned a dynamic range comparable to that observed in shelf waters in August 1995. Data are available in Web Appendix 3 at <http://www.aslo.org/lo/toc/vol47/issue.1/0176a3.pdf>. As previously observed near San Francisco, California (van Geen and Husby 1996), the seasonal upwelling cycle was less well defined for surfzone P than for Cd (Fig. 6d). Along the western U.S. coast, the composition of the water column typically

shifts to that of upwelling conditions in late spring, following several days of equatorward wind stress in excess of 2 dynes cm⁻² (Strub et al. 1987a). Increasing Cd and P concentrations in the surfzone indicate that this transition occurred in May in 1994 and 1995 (Fig. 6d). In 1996, the upwelling regime began slightly later (late May/early June) than in the two preceding years. A brief upwelling event occurred in mid-March, but was followed by a month of poleward winds and a return to winter-like tracer distributions. A second period of upwelling occurred in early May; however, low coastal salinity following the event indicated that the upwelling regime was not yet fully established. In late May of 1996 alongshore wind stress became persistently equatorward (Fig. 4a), followed by increases in all upwelling tracer concentrations. Throughout the year, sustained periods of either poleward or equatorward winds were interrupted by wind relaxation or reversal events, which occur frequently at the Oregon coast (Peterson et al. 1979; Huyer 1983; Strub et al. 1987b; Barth and Smith 1998). Following brief wind relaxation events, surfzone P concentrations tended to decline rapidly while Cd concentrations and salinity remained relatively constant (e.g., August 1994, Fig. 6c,d). Longer periods of wind relaxation were followed by decreases in surfzone P as well as decreases in salinity and Cd (e.g., June–July 1995, Fig. 6). During the fall of each year, surfzone Cd and P concentrations gradually declined as downwelling-favorable winds started to prevail. Average winter Cd and P concentrations in the surfzone, 0.2 nmol kg⁻¹ and 0.5 μmol kg⁻¹, respectively, were similar to concentrations observed far offshore of Cape Blanco (Fig. 4d,e,i,j). Decreases in surfzone salinity accompanied by higher silicate and nitrate concentrations (Web Appendix 3) indicate that there was a runoff component in the surfzone following winter storms.

Discussion

Cd as a tracer of upwelling—Two lines of evidence suggest that nearshore Cd is a more conservative upwelling tracer than nutrients: the divergent behavior of Cd and P during the incubation experiment (Fig. 5b,c) and the contrast in surface Cd and P distributions north and south of Cape Blanco (Fig. 4d,e,i,j). The biological “fractionation” between Cd and P that occurred in surface waters following upwelling resulted in considerably less Cd than P uptake compared to the Cd/P ratio in upwelling waters, which was similar to the average north Pacific subsurface ratio (Boyle et al. 1976; Bruland et al. 1978; Bruland 1980). Why would a phytoplankton assemblage dominated by coastal diatoms take up proportionately less Cd relative to the mean-ocean Cd/P ratio? Results obtained by incubating California coastal waters at different *p*CO₂ levels provide a possible explanation. Cullen et al. (1999) showed that Cd uptake by a natural phytoplankton assemblage was inversely related to ambient *p*CO₂, probably because Cd plays a role in carbon fixation through the formation of the enzyme Cd-carbonic anhydrase (Morel et al. 1994; Lee et al. 1995). Since newly upwelled surface waters are supersaturated in *p*CO₂ with respect to the atmosphere (up to 800 μatm, van Geen et al. 2000), regu-

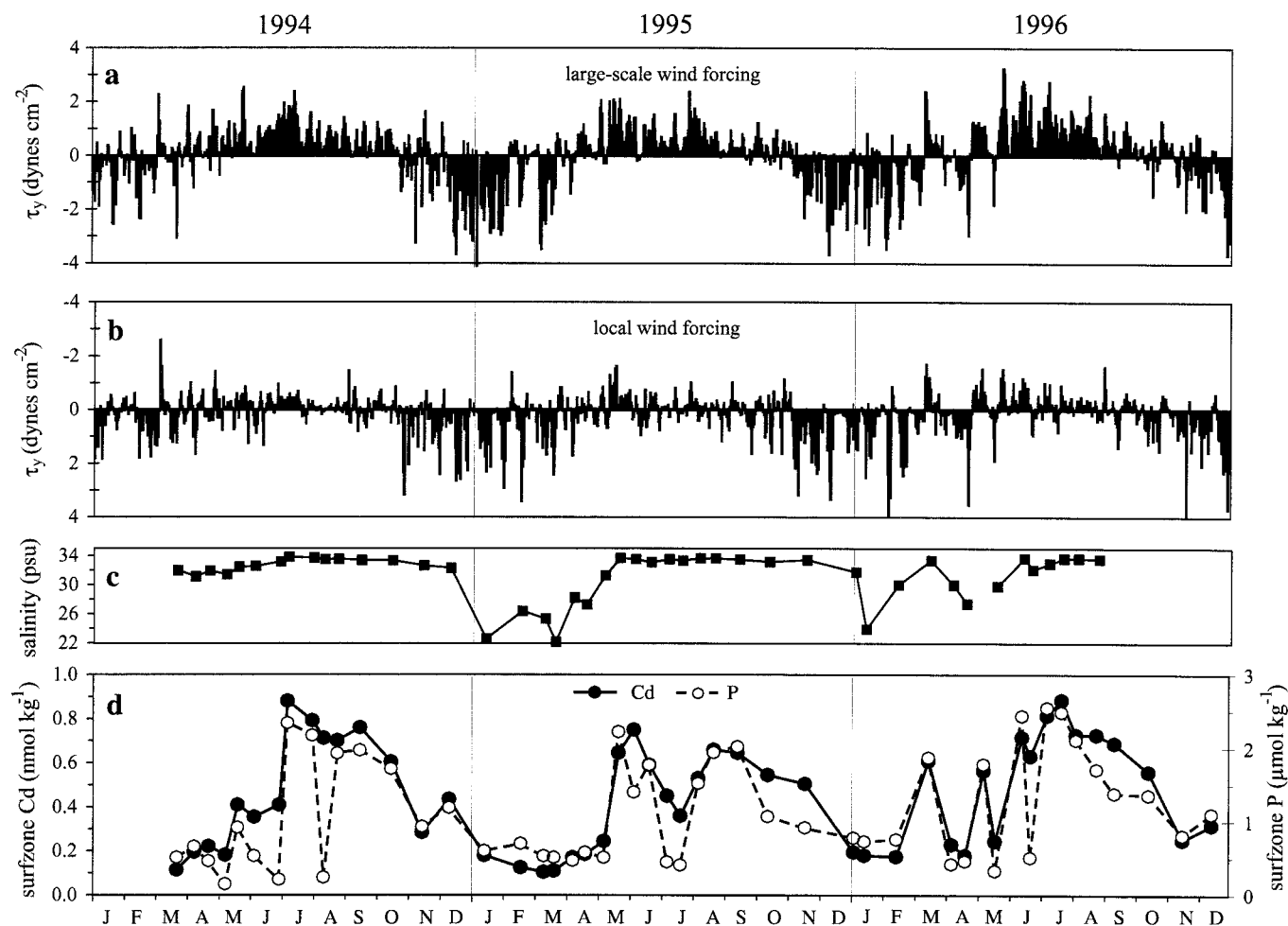

Fig. 6. Time series of (a) daily average large-scale alongshore wind stress calculated from the daily upwelling index at 42°N, 125°W (positive values are equatorward), (b) daily average alongshore wind stress calculated from local winds measured at the Cape Arago lighthouse (negative values are equatorward, note the y-axis is inverted), (c) surfzone salinity at Seven Devils beach, (d) surfzone Cd and P at Seven Devils beach during 1994–1996. The Cd and P axes in (d) have been scaled as in Fig. 4.

lation of Cd uptake by $p\text{CO}_2$ may explain why upwelling-induced enrichments persist longer for Cd than P. It is worth noting that Cullen et al. (1999) also found that Cd uptake was actually enhanced relative to P uptake in their experiment under $p\text{CO}_2 \sim 100 \mu\text{atm}$. Offshore of Cape Blanco, $p\text{CO}_2$ was undersaturated to comparable levels ($p\text{CO}_2 \sim 150 \mu\text{atm}$) due to a diatom bloom (Figs. 1 and 4c,g), yet a strong drawdown of Cd relative to P was not observed (Fig. 4c,d), probably because most of the P drawdown took place at

$p\text{CO}_2$ levels that were not conducive to preferential Cd uptake.

Our shore station and water column observations suggest that nearshore Cd and P enrichments are determined primarily by the intensity of coastal upwelling off the Oregon coast. While inputs from rivers or shelf sediments often cause nutrient and trace metal enrichments in coastal waters (Bruland and Franks 1983; Kremling 1983; Heggie et al. 1987; van Geen and Luoma 1993), neither source appears to account for summer Cd and P distributions at the Oregon coast. During the 1994–1996 upwelling seasons the surfzone contained on average less than 2% fresh water (assuming a salinity of 34 psu for upwelling source waters), and time series measurements near the mouth of Coos Bay estuary show that waters with salinities less than 24 psu have on average lower Cd and P concentrations than coastal waters (Table 1). In addition, the narrow geometry of the Oregon shelf and efficient cross-shore transport (Huyer 1983) limit interactions between sediments and bottom waters.

Could Cd and P enrichments in shelf bottom waters result from the remineralization of plankton matter in the shelf

Table 1. Upwelling tracer concentrations at the mouth of Coos Bay estuary and at Seven Devils beach during high river outflow conditions (14 Jan 95).

	Estuary	Beach
Salinity (psu)	15.711	22.572
Cd (nmol kg^{-1})	0.05	0.18
PO_4^{3-} ($\mu\text{mol kg}^{-1}$)	0.59	0.60
Si ($\mu\text{mol kg}^{-1}$)	92.68	39.81
NO_3^- ($\mu\text{mol kg}^{-1}$)	33.75	25.76

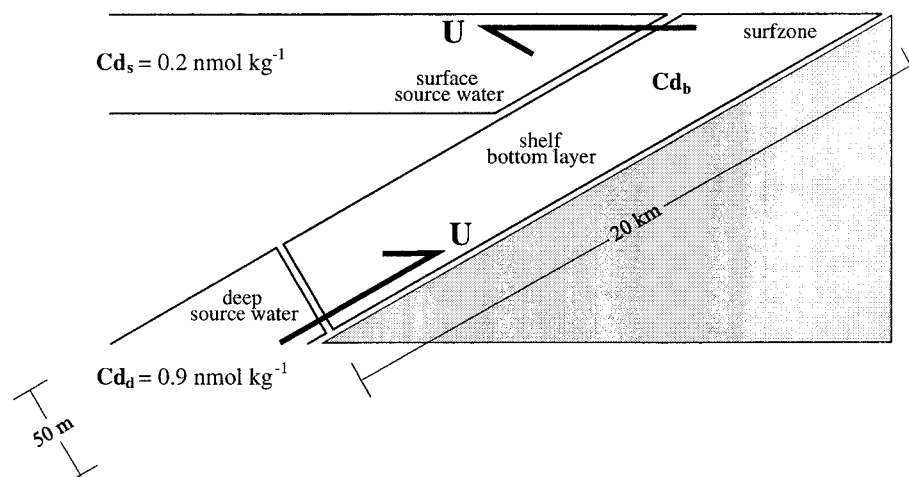

Fig. 7. Conceptualized box model showing the cross-shelf advection pathway during coastal upwelling from enriched source waters at depth, through a homogenous bottom layer, and into the depleted offshore surface layer. The flow reverses during downwelling.

water column, rather than wind-driven advection of waters from depth (e.g., Barber and Smith 1981)? The fractionation of Cd and P in coastal plankton provides a way to assess this possibility. Surface upwelling tracer distributions observed in August 1995 indicate that plankton that grew in the bloom region north of Cape Blanco had Cd/P ratios much lower than that of upwelling source waters. Significant remineralization of this plankton detritus over the shelf would have produced anomalously low Cd/P ratios. Since this was not observed, we conclude that shallow remineralization cannot account for Cd and P enrichments observed in southern Oregon shelf bottom waters. The absence of Cd and P sources from continental runoff, sediments, or shallow remineralization, combined with the observation that the Cd and P composition of upwelling shelf bottom waters (0.9 nmol kg^{-1} and $2.5 \text{ } \mu\text{mol kg}^{-1}$, respectively) closely matched that of offshore source waters, confirms that Cd- and P-enriched waters are transported onshore in the shelf bottom layer during coastal upwelling.

A box model for nearshore exchange—To confirm the link between alongshore wind forcing and nearshore variations in the upwelling-sensitive tracer Cd, a simple wind-driven box model is used to describe variations in surfzone Cd. Based on the Cd distribution across the Oregon shelf documented in this study, onshore transport during upwelling is assumed to take place in a shelf bottom layer, represented by a homogeneous box of composition Cd_b , that extends from the shelf edge to the surfzone (Fig. 7). While the inner shelf and very nearshore region are too shallow to allow the existence of a discrete bottom boundary layer (Lentz 1994), the rapid appearance of newly upwelled water in the surfzone indicates that mixing between the inner shelf, where upwelling occurs (Lentz 1994), and the very nearshore region is remarkably efficient. Thus for the purposes of this study, the use of a single well-mixed box to approximate exchange between the very nearshore region and inner shelf is an adequate representation of the first-order processes determining nearshore Cd concentrations during coastal up-

welling. Advection (U) through the box, with a magnitude equal to wind-driven Ekman transport, is onshore during upwelling and offshore during downwelling. The fixed volume (V) of the box is constrained by the 20 km width of the continental shelf and a constant height of 50 m, which is midway between the 20–80 m range of bottom boundary layer thickness observed off California by Lentz and Trowbridge (1991). The Cd concentrations of the deep and surface end members are fixed at 0.9 nmol kg^{-1} (Cd_d) and 0.2 nmol kg^{-1} (Cd_s), respectively, in accordance with observations offshore of Cape Blanco. Equations 1 and 2 are mass-balance expressions for the bottom layer box that assume continuity of volume at each time step during upwelling and downwelling, respectively

$$V \times (Cd_{b,new} - Cd_{b,old}) = (Cd_d \times U) - (Cd_{b,old} \times U) \quad (1)$$

$$V \times (Cd_{b,new} - Cd_{b,old}) = (Cd_s \times U) - (Cd_{b,old} \times U) \quad (2)$$

where “new” refers to the current time step and “old” refers to the previous time step. Rearranging these equations yields an expression for the surfzone Cd content at each time step

$$Cd_{b,new} = Cd_{b,old} + 1/V[(Cd_d - Cd_{b,old}) \times U] \quad (3)$$

$$Cd_{b,new} = Cd_{b,old} + 1/V[(Cd_s - Cd_{b,old}) \times U] \quad (4)$$

Estimates of large-scale and local wind forcing were used to drive the model. Both measures of wind forcing produced a seasonal cycle in surfzone Cd characterized by low offshore values in the winter and summer values approaching that of the enriched deep source waters (Fig. 8). An abrupt spring transition and a gradual decay to winter values in the fall were also adequately reproduced. For a steady equatorward wind stress of 2 dyne cm^{-2} , transport across the shelf and into the very nearshore region (i.e., the residence time of upwelling water in the bottom layer box) takes $\sim 1.5 \text{ d}$. Since in this simple model the box volume is fixed, transport times depend only on the magnitude of equatorward wind stress. The $\sim 1.5\text{-d}$ time lag between the onset of upwelling-favorable wind forcing and the appearance of upwelling conditions at the coast is consistent with the observations of

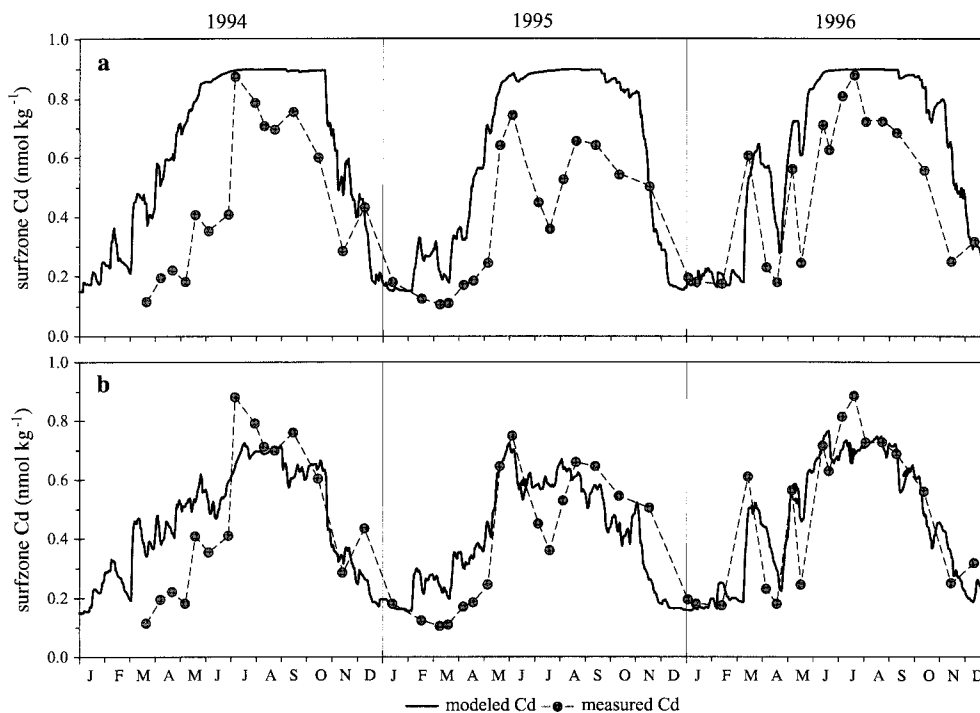

Fig. 8. Model-generated surfzone Cd (nmol kg^{-1}) forced with (a) large-scale wind stress calculated from the upwelling index at 42°N , 125°W and (b) local wind stress calculated from winds measured at the Cape Arago lighthouse. Measured surfzone Cd at Seven Devils Beach is shown for comparison.

Huyer et al. (1979) offshore of Newport, Oregon, during the 1975 spring transition.

The main difference between the two model-generated Cd time series is that Cd concentrations generated by the large-scale wind-forced model persist at the maximum source water value throughout the summer (Fig. 8a), while Cd concentrations generated by the local wind-forced model decrease to intermediate values that are much closer to observations (Fig. 8b). A comparison of the wind-forcing data sets (Fig. 6a,b) reveals that the anomalously strong and persistent summer upwelling generated by the large-scale wind-forced model can be attributed to an underestimation of summer wind relaxation and reversal events calculated by the upwelling index at 42°N . Halliwell and Allen (1987) showed that large-scale winds calculated from the upwelling index reproduced only 44% of the measured change from equatorward to poleward flow during a wind reversal event in early May 1982, probably because the small cross-shore scales of such events (a few hundred kilometers) cause them to be poorly resolved by the large-scale wind estimates. The good agreement between Cd time series generated by the local wind-forced model to observed surfzone Cd concentrations at Seven Devils Beach suggests that summer wind relaxation and reversal events play an equally important role as upwelling-favorable wind forcing in determining the composition of nearshore water.

The remarkable ability of the simple box model to closely reproduce observed nearshore Cd variations supports the notion that the very nearshore region, including the surfzone, exchanges with a bottom layer that extends to the edge of

the continental shelf (van Geen et al. 2000). Coastal Cd concentrations appear to be buffered against diurnal as well as day-to-day variations in wind forcing by advection through this well-mixed bottom layer. The efficient exchange of water between the bottom boundary layer and the very nearshore region during upwelling has a practical implication: surfzone sampling for Cd provides an effective way to monitor upwelling-induced nutrient enrichments in shelf waters.

Cd is a particularly effective tracer of coastal upwelling for several reasons: (1) Cd has a nutrient-like distribution in offshore source waters, (2) the Cd concentration of upwelling waters is conserved during onshore transport, (3) Cd is not taken up rapidly by phytoplankton in recently upwelled waters. These characteristics allowed us to demonstrate that onshore transport during upwelling occurs through a bottom boundary layer over the shelf and that newly upwelled water is efficiently mixed into the surfzone. A simple box model shows that both upwelling-favorable alongshore wind forcing and summer wind relaxation and reversal events determine the composition of nearshore waters in a predictable fashion.

References

- ABBOTT, M. R., AND B. BARKSDALE. 1991. Phytoplankton pigment patterns and wind forcing off central California. *J. Geophys. Res.* **96**: 14,649–14,667.
- BAKUN, A. 1975. Daily and weekly upwelling indices, west coast of North America, 1967–1973. NOAA Tech. Rep. NMFS SSRF-693.

- , AND C. S. NELSON. 1991. The seasonal cycle of wind-stress curl in subtropical eastern boundary current regions. *J. Phys. Oceanogr.* **21**: 1815–1834.
- BARBER, R. T., AND R. L. SMITH. 1981. Coastal upwelling ecosystems, p. 31–68. *In* A. R. Longhurst [ed.], *Analysis of marine ecosystems*. Academic.
- BARTH, J. A., S. D. PIERCE, AND R. L. SMITH. 2000. A separating coastal upwelling jet at Cape Blanco, Oregon and its connection to the California Current System. *Deep-Sea Res. II* **47**: 783–810.
- , AND R. L. SMITH. 1998. Separation of a coastal upwelling jet at Cape Blanco, Oregon, USA. *S. Afr. J. Mar. Sci.* **19**: 5–14.
- BEARDSLEY, R. C., C. E. DORMAN, C. A. FRIEHE, L. K. ROSENFELD, AND C. D. WINANT. 1987. Local atmospheric forcing during the Coastal Ocean Dynamics Experiment, 1. A description of the marine boundary layer and atmospheric conditions over a northern California upwelling region. *J. Geophys. Res.* **92**: 1467–1488.
- BOYLE, E. A., S. S. HUESTED, AND B. GRANT. 1982. The chemical mass balance of the Amazon River plume—II. Copper, nickel, and cadmium. *Deep-Sea Res.* **29**: 1355–1364.
- , F. SCLATER, AND J. M. EDMOND. 1976. On the marine geochemistry of cadmium. *Nature* **236**: 42–44.
- BRULAND, K. W. 1980. Oceanographic distributions of cadmium, zinc, nickel, and copper in the north Pacific. *Earth Planet. Sci. Lett.* **47**: 176–198.
- , AND R. P. FRANKS. 1983. Mn, Cu, Ni, Zn, and Cd in the western North-Atlantic, p. 395–413. *In* C. S. Wong, E. A. Boyle, K. W. Bruland, and E. D. Goldberg [eds.], *Trace metals in seawater*. Plenum.
- , G. A. KNAUER, AND J. H. MARTIN. 1978. Cadmium in the northeast Pacific. *Limnol. Oceanogr.* **23**: 618–625.
- CHAVEZ, F. P., R. T. BARBER, P. M. KORSO, A. HUYER, S. R. RAMP, T. P. STANTON, AND B. ROJAS DE MENDIOLA. 1991. Horizontal transport and the distribution of nutrients in the coastal transition zone off northern California: Effects on primary production, phytoplankton biomass, and species composition. *J. Geophys. Res.* **96**: 14833–14848.
- , AND J. R. TOGGWEILER. 1995. Physical estimates of global new production: The upwelling contribution. *In* C. P. Summerhayes, K.-C. Emeis, M. V. Angel, R. L. Smith, and B. Zeitzechel [eds.], *Upwelling in the ocean modern processes and ancient records*. Wiley.
- CULLEN, J. T., T. W. LANE, F. M. M. MOREL, AND R. M. SHERRELL. 1999. Modulation of cadmium uptake in phytoplankton by seawater CO₂ concentration. *Nature* **402**: 165–167.
- HALLIWELL, G. R., AND J. S. ALLEN. 1987. Large-scale coastal wind field along the west coast of North America. *J. Geophys. Res.* **92**: 1861–1884.
- HEGGIE, D., G. KLINKHAMMER, AND D. CULLEN. 1987. Manganese and copper fluxes from continental margin sediments. *Geochim. Cosmochim. Acta* **51**: 1059–1070.
- HUYER, A. 1983. Coastal upwelling in the California Current system. *Prog. Oceanogr.* **12**: 259–284.
- , J. C. SOBIEY, AND R. L. SMITH. 1979. The spring transition in currents over the Oregon continental shelf. *J. Geophys. Res.* **84**: 6995–7011.
- KNAUER, G. A., AND J. H. MARTIN. 1981. Phosphorus-cadmium cycling in northeast Pacific waters. *J. Mar. Res.* **39**: 65–76.
- KREMLING, K. 1983. Trace metal fronts in European shelf waters. *Nature* **303**: 225–227.
- LANDING, W. M., C. HARALDSSON, AND N. PAXEUS. 1986. Vinyl polymer agglomerate based transition metal cation chelating resin containing the 8-hydroxyquinoline group. *Anal. Chem.* **58**: 3031–3035.
- LEE, J. G., S. B. ROBERTS, AND F. M. M. MOREL. 1995. Cadmium: A nutrient for the marine diatom. *Limnol. Oceanogr.* **40**: 1056–1063.
- LENTZ, S. J. 1994. Current dynamics over the northern California inner shelf. *J. Phys. Oceanogr.* **24**: 2461–2478.
- , AND J. H. TROWBRIDGE. 1991. The bottom boundary layer over the northern California shelf. *J. Phys. Oceanogr.* **21**: 1186–1201.
- MANN, K. H. 1993. Physical oceanography, food chains, and fish stocks: A review. *J. Mar. Sci.* **50**: 105–119.
- MARTIN, J. H., K. W. BRULAND, AND W. W. BROEKOW. 1976. Cadmium transport in the California Current, p. 159–184. *In* H. L. Windom and R. A. Duce [eds.], *Marine pollutant transfer*. Skidaway Institute of Oceanography.
- MOREL, F. M. M., J. R. REINFELDER, S. B. ROBERTS, C. P. CHAMBERLAIN, J. G. LEE, AND D. YEE. 1994. Zinc and carbon co-limitation of marine phytoplankton. *Nature* **369**: 740–742.
- PETERSON, W. T., C. B. MILLER, AND A. HUTCHINSON. 1979. Zonation and maintenance of copepod populations in the Oregon upwelling zone. *Deep-Sea Res.* **26A**: 467–494.
- RYTHER, J. H., AND W. M. DUNSTAN. 1969. Nitrogen, phosphorus, and eutrophication in the coastal marine environment. *Science* **171**: 1008–1102.
- STRICKLAND, J. D. H., AND T. R. PARSONS. 1968. *A practical handbook of seawater analysis*. Fish. Res. Board Can. Bull. 167.
- STRUB, P. T., J. S. ALLEN, A. HUYER, AND R. L. SMITH. 1987a. Large-scale structure of the spring transition in the coastal ocean off western North America. *J. Geophys. Res.* **92**: 1527–1544.
- , ———, ———, ———, AND R. C. BEARDSLEY. 1987b. Seasonal cycles of currents, temperatures, winds, and sea level over the northeast Pacific continental shelf: 35°N to 48°N. *J. Geophys. Res.* **92**: 1507–1526.
- TAYLOR, F. J. R. 1976. Flagellates. *Monog. Oceanog. Methodol.* **4**: 259–264.
- VAN GEEN, A., AND D. M. HUSBY. 1996. Cadmium in the California Current system: A tracer of past and present upwelling. *J. Geophys. Res.* **101**: 3489–3507.
- , AND S. N. LUOMA. 1993. Trace metals Cd, Cu, Ni, Zn, and nutrients in coastal waters adjacent to San Francisco Bay, California. *Estuaries* **16**: 559–566.
- , ———, C. C. FULLER, R. ANIMA, H. E. CLIFTON, AND S. TRUMBORE. 1992. Evidence from Cd/Ca ratios in foraminifera for greater upwelling off California 4,000 years ago. *Nature* **358**: 54–56.
- , R. K. TAKESUE, J. GODDARD, T. TAKAHASHI, J. A. BARTH, AND R. L. SMITH. 2000. Carbon and nutrient dynamics during coastal upwelling off Cape Blanco, Oregon. *Deep-Sea Res. II* **47**: 975–1002.

Received: 6 April 2000

Accepted: 28 August 2001

Amended: 1 October 2001